



Accessories for power quality analyzers

Reach for more capabilities



measurements



installation



communication



software



power supply



transportation



measurements

Flexible coils



F-x clamps

Flexible coils, also referred to as Rogowski coils, are used for measurements of alternating currents in hard-to-access points, where it is not possible to clamp fixed jaws. They enable the measurements of current levels up to 6000 A. With the 5-pin termination, they are connected directly to the power quality analyzers.

Name	Diameter	Rated current	Type of current	Index
F-1A1	Ø 360 mm	1.5 kA	AC	WACEGF1A1OKR
F-1A		3 kA		WACEGF1A0KR
F-1A6		6 kA		WACEGF1A6OKR
F-2A1	Ø 235 mm	1.5 kA		WACEGF2A1OKR
F-2A		3 kA		WACEGF2A0KR
F-2A6		6 kA		WACEGF2A6OKR
F-3A1	Ø 120 mm	1.5 kA	WACEGF3A1OKR	
F-3A		3 kA	WACEGF3A0KR	
F-3A6		6 kA	WACEGF3A6OKR	

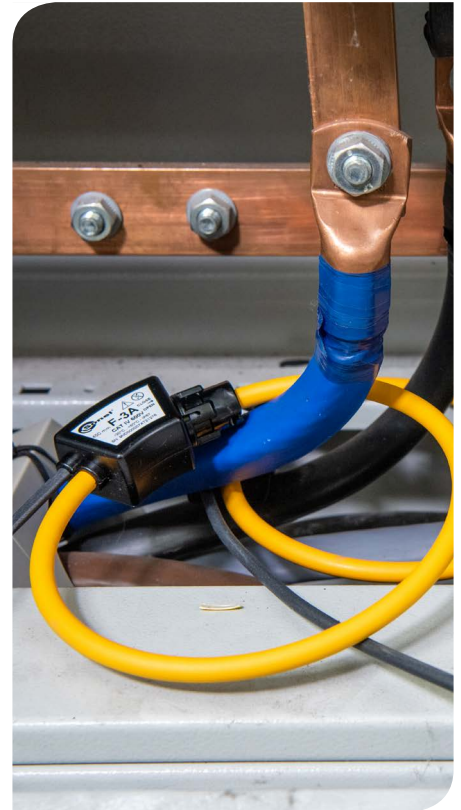

Accessories dedicated to the following instruments:

PQM-700 PQM-702 PQM-703 PQM-707 PQM-710 PQM-711

Current clamps

Split-Core current clamps are used for measuring alternating and direct currents. They are available in four variants of different diameters of the clamped conductor and the type of current to be measured. All models are terminated with a 5-pin connector.



C-4A current clamp



C-5A current clamp



C-6A current clamp



C-7A current clamp

Name	Diameter	Rated current	Type of current	Index
C-4A	Ø 52 mm	1000 A	AC	WACEGC4A0KR
C-5A	Ø 39 mm	1000 A	AC/DC	WACEGC5A0KR
C-6A	Ø 20 mm	10 A	AC	WACEGC6A0KR
C-7A	Ø 24 mm	100 A	AC	WACEGC7A0KR



Accessories dedicated to the following instruments:

PQM-700 PQM-702 PQM-703 PQM-707 PQM-710 PQM-711

Comparison of current clamps

	C-4A	C-5A	C-6A	C-7A	F-1A1 / F-1A / F-1A6	F-2A1 / F-2A / F-2A6	F-3A1 / F-3A / F-3A6
	WACEGC4AOKR	WACEGC5AOKR	WACEGC6AOKR	WACEGC7AOKR	WACEGF1A1OKR WACEGF1AOKR WACEGF1A6OKR	WACEGF2A1OKR WACEGF2AOKR WACEGF2A6OKR	WACEGF3A1OKR WACEGF3AOKR WACEGF3A6OKR
Rated current	1000 A AC	1000 A AC 1400 A DC	10 A AC	100 A AC	1500 / 3000 / 6000 A AC		
Frequency	30 Hz...10 kHz	DC...5 kHz	40 Hz...10 kHz	40 Hz...1 kHz	40 Hz...10 kHz		
Output signal level	1 mV 1 A	1 mV 1 A	100 mV 1 A	5 mV 1 A	77.6 / 38.8 / 19.4 μ V 1 A		
Max. diameter of measured conductor	52 mm	39 mm	20 mm	24 mm	360 mm	235 mm	120 mm
Min. basic accuracy	$\leq 0,5\%$	$\leq 1,5\%$	$\leq 1\%$	0,5%	1%		
Battery power	–	✓	–	–	–		
Lead length		2.2 m		3 m	2.2 m		
Measurement category		IV 300 V		III 300 V	IV 600 V		
Housing protection class		IP40			IP67		



AC-16 line splitter

index: WAADAAC16

AC-16 has been designed to simplify current and voltage measurements: it eliminates the need to remove the electrical sockets. It is dedicated for use in earthed networks. The unit is equipped with a 1:1 (X1) ratio and 10:1 (X10) ratio. The maximum current load is 16 A. The adapter can be used with any type of clamps offered by SONEL S.A.

Accessories dedicated to the following instruments:

PQM-700 PQM-702 PQM-703 PQM-707 PQM-710 PQM-711



AGT-16T adapter



AGT-32P adapter



AGT-63P adapter

Industrial socket adapters

Adapters enabling the connection of instruments to single-phase or three-phase sockets in industry environments. Offered in three current load versions – 16 A, 32 A and 63 A – as well as variants with 4 and 5 pins for the 3-phase outlets.

Name	Intended use	Index
AGT-16T	16 A, 1-phase, 3-pole sockets	WAADAAGT16T
AGT-16C	16 A, 3-phase, 4-pole sockets	WAADAAGT16C
AGT-16P	16 A, 3-phase, 5-pole sockets	WAADAAGT16P
AGT-32T	32 A, 1-phase, 3-pole sockets	WAADAAGT32T
AGT-32C	32 A, 3-phase, 4-pole sockets	WAADAAGT32C
AGT-32P	32 A, 3-phase, 5-pole sockets	WAADAAGT32P
AGT-63P	63 A, 3-phase, 5-pole sockets	WAADAAGT63P

Accessories dedicated to the following instruments:

PQM-700 PQM-702 PQM-703 PQM-707 PQM-710 PQM-711





measurements



Adapters for control terminals

index: WAADAPRKPL1

Adapters enabling the connection of the analyzer to terminal strips and test points in electrical switchgear units. Measuring category CAT II / 1000 V. The kit includes 5 adapters.

Accessories dedicated to the following instruments:

PQM-700 PQM-702 PQM-703 PQM-707 PQM-710 PQM-711



Magnetic voltage adapters

index: WAADAUMAGKPL

Adapters enabling the connection of the instrument directly to protective devices in the electrical switchgear. Fast and easy installation means electricians and maintenance personnel save time. Special design to prevent accidental disconnection of the adapter from the fixing point.

Accessories dedicated to the following instruments:

PQM-700 PQM-702 PQM-703 PQM-707 PQM-710 PQM-711

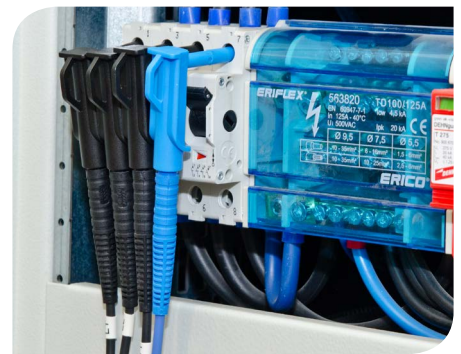

Voltage adapters

index: WAADAM4M6

Adapters enabling the connection of the analyzer directly to DIN rail terminal blocks in electrical switchgear units. Each adapter offers M4 / M6 thread. Versatility of this solution is unique on a global scale. The kit includes 5 adapters.

Accessories dedicated to the following instruments:

PQM-700 PQM-702 PQM-703 PQM-707 PQM-710 PQM-711

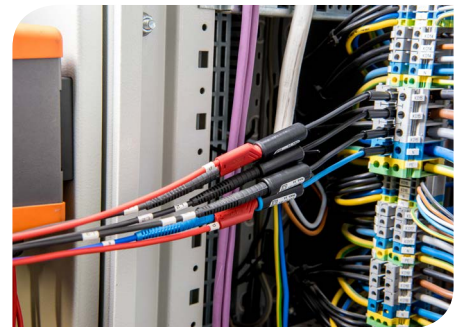

ASX-1 piercing adapter

index: WAADAPRZASX1KPL

The adapter is designed for mounting on insulated lines with aluminum or copper core and a cross section of 16-150 mm² / 1.5-16 mm². ASX-1 consists of a piercing probe and a test lead with $\Phi 4$ mm terminal. The set includes 4 adapters.

Both the body of the probe and the terminal are made of high quality composite material and elastomer – this guarantees resistance to atmospheric influences and UV radiation. The piercing element is made of stainless steel and the head - of aluminum, which ensures the repeatability of the tightening torque.

Accessories dedicated to the following instruments:

PQM-700 PQM-702 PQM-703 PQM-707 PQM-710 PQM-711





Voltage adapter for energy measuring terminal block

index: WAADASKA

The adapter allows the meter to be connected to the SKA-type test and control strip. The adapter plug is adjusted to the dimensions of the test sockets in the strips, while its socket is a standard 4 mm banana input for connecting the test lead. The kit includes 5 adapters.

Accessories dedicated to the following instruments:

PQM-700 PQM-702 PQM-703 PQM-707 PQM-710 PQM-711

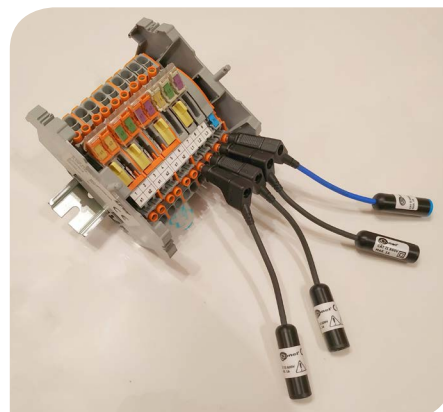

Voltage probe for internal hex screws

index: WASONVG6GBKPL

It is designed for quick and safe connection of test leads with hexagon socket head cap screws. Turning the button on the back of the housing opens the probe tip. As a result, it sits firmly inside the screw head, ensuring contact at many points, which reduces the resistance of the connection. The probe socket has a standard 4 mm banana input for connecting the test lead. The kit includes 5 probes.

Accessories dedicated to the following instruments:

PQM-700 PQM-702 PQM-703 PQM-707 PQM-710 PQM-711



Voltage probe with grasper

index: WASONKGB1KPL

It is used for connecting voltage test leads in hard-to-access points. Examples of use: elements of switchgear cabinets: bolts, nuts or busbars. The kit includes 5 test probes.

Accessories dedicated to the following instruments:

PQM-700 PQM-702 PQM-703 PQM-707 PQM-710 PQM-711

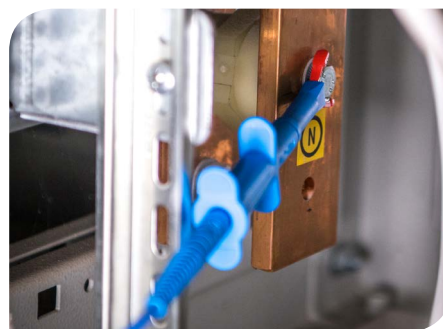

Flat test clip

index: WASONCGB1KPL

It is used for connecting voltage cables in hard to reach places. Exemplary application objects are elements of switchboard equipment: busbars, bolts or nuts. The set includes 5 probes.

Accessories dedicated to the following instruments:

PQM-700 PQM-702 PQM-703 PQM-707 PQM-710 PQM-711





installation

DIN rail mounting bracket with positioning catches



index: WAPOZUCH3

Elements of this accessory kit enable the solid and permanent suspension of PQM devices on DIN rails, which are popular in switchgear cabinets. Thanks to the special design, the risk of accidentally knocking the instrument off is practically eliminated.

The bracket should be screwed to the rear panel of the analyzer, using the supplied screws. Additionally, the kit includes positioning catches. They are equipped with special hooks that are supported on the DIN rail to improve the stability of the instrument mounting.

Accessories dedicated to the following instruments:

PQM-700 PQM-702 PQM-703 PQM-710 PQM-711



Mounting on the pole

The analyzer is designed for operation in adverse weather conditions – it can be installed directly on power transmission poles. This is ensured by the kit, which includes:

- mounting bracket for poles straps (2 pcs set),
- straps for pole mounting.

It is an effective solution, appreciated by all fitters who can perform the task quickly and without the need to use additional tools.



Mounting bracket for poles straps

index: WAPOZUCH4

Screwed to the rear panel of the analyzer, they form slots for attaching the straps. This way, the instrument can be mounted on the pole.



Straps for mounting on the pole

index: WAPOZOPAKPL

Strap length is 120 cm. They can be used for mounting items on poles with different diameters or structures: both pre-stressed concrete and lattice steel types.

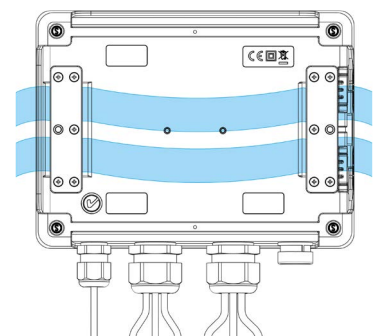

Accessories dedicated to the following instruments:

PQM-700 PQM-702 PQM-703 PQM-710 PQM-711



Magnetic holders

index: WAPOZUCH5

The set includes two holders that are screwed to the rear panel of the analyzer. They are used to mount the instrument on metal surfaces. Magnets with a high attraction force prevent the instrument from sliding down – e.g. on the doors of switchgear panels – despite the load resulting from the forces acting on the analyzer and measuring leads.



Accessories dedicated to the following instruments:

PQM-700 PQM-702 PQM-703 PQM-710 PQM-711



Cover with a magnetic strap

index: WAPOZUCH8

It is designed for fixing the analyzer to metal surfaces. It holds the power supply adapter. It allows measuring leads and power cables to be arranged. The kit includes a special case equipped with holders for the connection of the strap with a magnetic lock. Neodymium magnets used in the lock prevent the instrument from sliding down – also from painted metal surfaces.

Accessories dedicated to the following instruments:

PQM-707





communication



GPS antenna

index: WAPOZANT10GPS

The antenna allows time synchronization via GPS when the analyzer is used indoors. The length of the lead is 10 m. Thanks to a magnetic holder, the antenna can be mounted on any metal surface, e.g. transformer chamber door.



Accessories dedicated to the following instruments:

PQM-702

PQM-703

PQM-710

PQM-711



GSM signal repeater

index: WAPOZANTREPEATER

When the analyzer is required to receive a GSM signal, but there is a poor reception at the place of installation - use a signal repeater.

The kit includes two antennas. The first is attached to the analyzer housing. The second must be placed outside the poor GSM reception zone.



Accessories dedicated to the following instruments:

PQM-702

PQM-703

PQM-710

PQM-711



USB cable

index: WAPRZUSB

The cable with connectors of A and B type, compatible with USB 1.1 and 2.0. It is intended to connect the computer to Sonel devices equipped with USB sockets of B type. The cable is used to transfer the measurement results, configurations and updating the firmware of many meters.

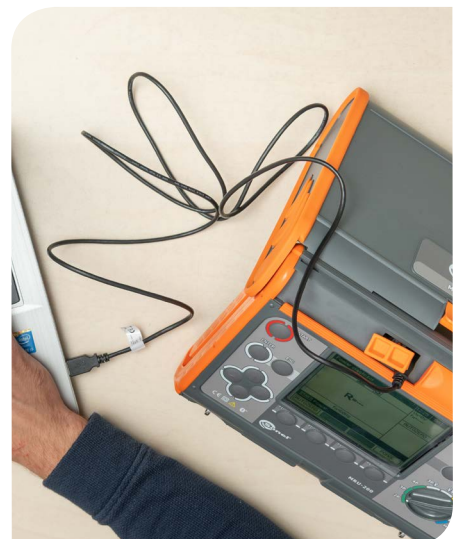

Accessories dedicated to the following instruments:

PQM-700

PQM-702

PQM-703

PQM-707

PQM-710

PQM-711



software

Sonel Analysis



index: WAPROANALIZA4

Application indispensable for working with PQM-series analyzers. It enables:

- analyzer configuration,
- data reading from logger,
- preview of network parameters in real time (with capability of reading via GSM modem),
- deletion of data in the analyzer,
- data presentation in tables,
- data presentation in charts,
- data analysis in compliance with standard EN 50160 (reports) and other user-defined reference conditions,
- independent support of multiple analyzers,
- analyzer firmware updates.

Sonel Analysis software enables reading of selected parameters and their graphic presentation in real time. These parameters are measured independently of the registration saved on the memory card.

Thanks to the software the user can read data stored on the memory card and analyze them. There is also an option to save the data to the computer's hard drive for archiving or subsequent processing.

With data from the analyzer user can prepare reports according to EN 50160 standard, as well as user criteria. The files are generated to PDF, HTML, CSV or TXT format.

Program dedykowany do przyrządów:

- PQM-700
- PQM-702
- PQM-703
- PQM-707
- PQM-710
- PQM-711

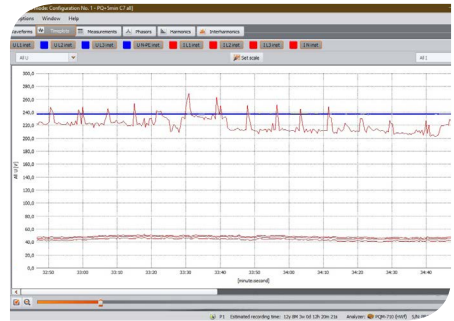
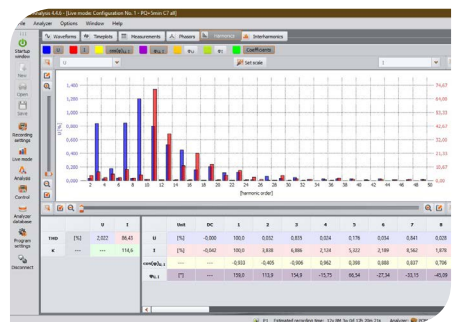
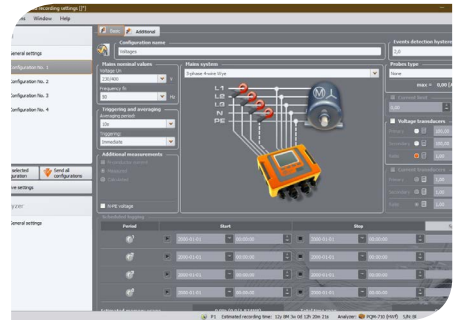

Sonel Analysis Mobile



Mobile version of the program cooperating with PQM-711 and PQM-710 analyzers. With the application, you can connect directly to your device via the Wi-Fi interface and check of current readings of network parameters to which the analyzer is connected.

Useful for users can be remotely start/stop recording, and to change the measurement point (configuration) in the analyzer.

Program dedykowany do przyrządów:

- PQM-710
- PQM-711

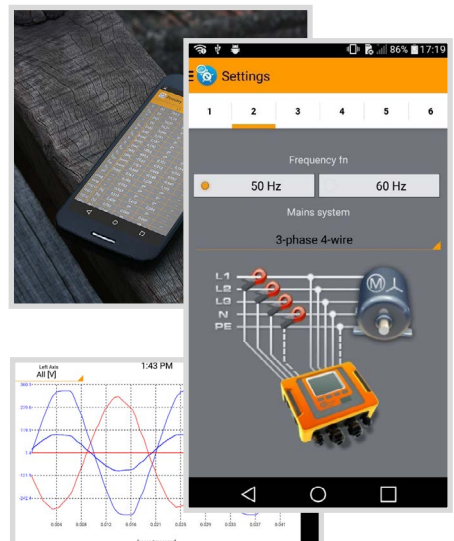



power supply



Power supply adapter AZ-1

index: WAADAAZ1

Mains plug with banana sockets (L and N). It enables the charging of the analyzer batteries from the power supply socket, while eliminating the need to connect the instrument to the measured object. It is particularly useful when copying data, analyzing results or transferring the configuration: there is no risk of the device battery unexpectedly discharging when performing such operations.

Accessories dedicated to the following instruments:

PQM-700 PQM-702 PQM-703 PQM-710 PQM-711

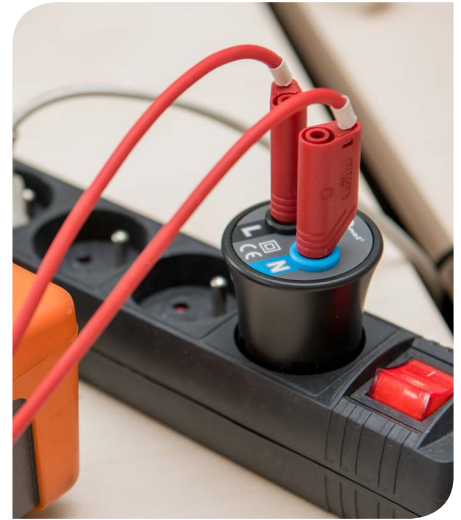

AZ-2 power supply adapter

index: WAADAAZ2

Designed for charging the analyzer battery directly from the electrical switchgear. It is particularly useful during long-term monitoring on facilities, where using the grid socket is not possible. Safety stackable plugs enable the charging of the analyzer while still having the option to perform measurements. Connected to the power supply adapter with an IEC C8 connector, AZ-2 does not require any additional adapters to function properly.

Accessories dedicated to the following instruments:

PQM-707



Cable for battery charging from car cigarette lighter socket (12 V)

index: WAPRZLAD12SAM

Connected directly to the analyzer. It enables the battery to be charged when the only available source of power is the cigarette lighter socket in a vehicle. Discharged battery? No available power outlet or circuits for instrument charging? Thanks to this accessory, all the required measurements can be carried out. The cable can be also used for other instruments offered by SONEL S.A.

Accessories dedicated to the following instruments:

PQM-707

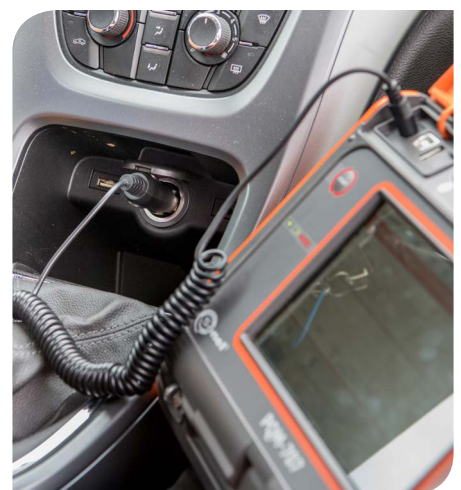



transportation



L-2 hard carrying case

index: WAWALL2

It ensures the safe transport and storage of measuring clamps.

Accessories dedicated to the following instruments:

PQM-700 PQM-702 PQM-703 PQM-707 PQM-710 PQM-711



XL-2 hard carrying case

index: WAWALXL2

It ensures the safe transport and storage of the analyzer together with its accessories.

Accessories dedicated to the following instruments:

PQM-700 PQM-702 PQM-703 PQM-710 PQM-711



XL-12 hard carrying case

index: WAWALXL12

It ensures the safe transport and storage of the analyzer together with its accessories. A large number of compartments allows for effective protection of a large amount of equipment.

Accessories dedicated to the following instruments:

PQM-707 PQM-710 PQM-711









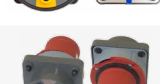









Photo	Name	Index	PQM-711	PQM-710	PQM-707	PQM-703	PQM-702	PQM-700
	AGT-16C adapter (for 3-phase outlets)	WAADAAGT16C	•	•	•	•	•	•
	AGT-16P adapter (for 3-phase outlets)	WAADAAGT16P	•	•	•	•	•	•
	AGT-16T adapter (for industrial outlets)	WAADAAGT16T	•	•	•	•	•	•
	AGT-32C adapter (for 3-phase outlets)	WAADAAGT32C	•	•	•	•	•	•
	AGT-32P adapter (for 3-phase outlets)	WAADAAGT32P	•	•	•	•	•	•
	AGT-32T adapter (for industrial outlets)	WAADAAGT32T	•	•	•	•	•	•
	AGT-63P adapter (for 3-phase outlets)	WAADAAGT63P	•	•	•	•	•	•
	cable adapter for control terminals CAT II / 1000 V (5 pcs.)	WAADAPRZKPL1	•	•	•	•	•	•
	voltage adapter for energy measuring terminal block (5 pcs)	WAADASKA	•	•	•	•	•	•
	magnetic adapter (4 pcs.)	WAADAUMAGKPL	1	1	1	1	1	1
	magnetic adapter, black	WAADAUMAGKBL	•	•	•	•	•	•
	magnetic adapter, blue	WAADAUMAGKBU	•	•	•	•	•	•
	voltage adapter with M4 / M6 thread	WAADAM4M6	1	1	•	1	1	•
	AC-16 line splitter adapter	WAADAAC16	1	1	1	1	1	•
	AZ-1 power supply adapter (mains plug / banana sockets)	WAADAAZ1	1	1		1	1	1
	AZ-2 power supply adapter (IEC C7 plug / banana sockets)	WAADAAZ2			1			

















Photo	Name	Index	PQM-711	PQM-710	PQM-707	PQM-703	PQM-702	PQM-700
	Li-Ion 3.6 V 4.5 Ah battery (replaceable in the SONEL S.A. service)	WAAKU11	1	1		1	1	1
	Li-Ion 11.1 V 3.4 Ah battery	WAAKU15			1			
	GPS antenna	WAPOZANT10GPS	•	•		•	•	
	GSM signal repeater	WAPOZANTREPEATER	•	•		•	•	
	flexible clamp F-1A (Ø 360 mm) 3 kA	WACEGF1AOKR	•	•	•	•	•	•
	flexible clamp F-2A (Ø 235 mm) 3 kA	WACEGF2AOKR	•	•	•	•	•	•
	flexible clamp F-3A (Ø 120 mm) 3 kA	WACEGF3AOKR	•	•	4	•	•	•
	flexible clamp F-1A1 (Ø 360 mm) 1.5 kA F-1A6 (Ø 360 mm) 6 kA	WACEGF1A1OKR WACEGF1A6OKR	•	•	•	•	•	•
	flexible clamp F-2A1 (Ø 235 mm) 1.5 kA F-2A6 (Ø 235 mm) 6 kA	WACEGF2A1OKR WACEGF2A6OKR	•	•	•	•	•	•
	flexible clamp F-3A1 (Ø 120 mm) 1.5 kA F-3A6 (Ø 120 mm) 6 kA	WACEGF3A1OKR WACEGF3A6OKR	•	•	•	•	•	•
	C-4A current clamp (Ø 52 mm) 1000 A AC	WACEGC4AOKR	•	•	•	•	•	•
	C-5A current clamp (Ø 39 mm) 1000 A AC/DC	WACEGC5AOKR	•	•	•	•	•	•
	C-6A current clamp (Ø 20 mm) 10 A AC	WACEGC6AOKR	•	•	•	•	•	•
	C-7A current clamp (Ø 24 mm) 100 A AC	WACEGC7AOKR	•	•	•	•	•	•
	L-4 carrying case	WAFUTL4			1			
	L-5 carrying case	WAFUTL5						1































Photo	Name	Index	PQM-711	PQM-710	PQM-707	PQM-703	PQM-702	PQM-700
	crocodile clip, black 1 kV 20 A	WAKROBL20K01	3	3	3	3	3	3
	crocodile clip, red 1 kV 20 A	WAKRORE20K02	2	2	2	2	2	2
	crocodile clip, blue 1 kV 20 A	WAKROBU20K02	1	1	1	1	1	1
	crocodile clip, yellow 1 kV 20 A	WAKROYE20K02	1	1	1	1	1	
	lead 2.2 m, black 1 kV (banana sockets)	WAPRZ2X2BLBB			3			
	lead 2.2 m, blue 1 kV (banana sockets)	WAPRZ2X2BUBB			1			
	lead 2.2 m, yellow-green 1 kV (banana sockets)	WAPRZ2X2YEBB			1			
	USB data transmission cable	WAPRZUSB	1	1	1	1	1	1
	pin probe, black 1 kV (banana socket)	WASONBLOGB1				•		
	pin probe, red 1 kV (banana socket)	WASONREOGB1				•		
	pin probe, blue 1 kV (banana socket)	WASONBUOGB1				•		
	pin probe, yellow 1 kV (banana socket)	WASONYE0GB1				•		
	voltage probe with grasper (5 pcs.)	WASONKGB1KPL	•	•	•	•	•	•
	voltage probe with grasper black	WASONBLCGB1	•	•	•	•	•	•
	voltage probe with grasper blue	WASONBUCGB1	•	•	•	•	•	•
	voltage probe with grasper green	WASONGRCGB1	•	•	•	•	•	•

Photo	Name	Index	PQM-711	PQM-710	PQM-707	PQM-703	PQM-702	PQM-700
	flat test clip (5 pcs.)	WASONCGB1KPL	•	•	•	•	•	•
	voltage probe for internal hex screws M6 with banana socket (5 pcs.)	WASONVG6GBKPL	•	•	•	•	•	•
	ASX-1 piercing adapter (4 pcs.)	WAADAPRZASX1KPL	•	•	•	•	•	•
	hanging straps (type L-2)	WAPOZSZEKPL			1			
	strap for mounting on the pole (set)	WAPOZOPAKPL	1	1		1	1	1
	DIN rail mounting bracket with positioning catches	WAPOZUCH3	1	1		1	1	1
	plates for pole mounting	WAPOZUCH4	2	2		2	2	2
	magnetic holder for mounting the meter (2 pcs.)	WAPOZUCH5	•	•		•	•	•
	Case for hanging with a magnetic strap (universal)	WAPOZUCH8			•			
	hard carrying case for clamps	WAWALL2	•	•	•	•	•	•
	XL-2 hard case	WAWALXL2	•	•		1	1	•
	XL-12 hard case	WAWALXL12	1	1	•			
	cable for battery charging from the car lighter socket 12 V	WAPRZLAD12SAM				1		
	mains cable 230 V (IEC C7 plug)	WAPRZLAD230				1		
	Z7 power supply adaptor	WAZASZ7				1		

1, 2, 4 – the number of standard accessories
• - optional accessory

