

**MVS**  
Soft Starter

AuCom



# MVS

Soft Starter

AuCom's MVS medium voltage soft starters are an integrated solution for motor control and protection. MVS soft starters combine advanced soft start and soft stop functionality with extensive motor and system protection, plus a user-friendly interface and complete commissioning diagnostics.

MVS soft starters provide integrated motor starting and monitoring functions for the most demanding industrial situations. Advanced algorithms ensure ultra-smooth starting and stopping, and fully adjustable protection features maximise electrical and mechanical protection for your motor and system. A large-format display and detailed performance logs make setup and operation simple.

MVS soft starters are available in either IP42 or IP54 panels, with options for line and bypass contactors, earthing and isolation switches. AuCom can also design and build panels to meet particular specifications, and we offer full applications engineering support at all stages of the design process. For customers who prefer to build their own panels, MVS soft starters can be supplied in IP00 format or as a kit for local assembly.

MVS soft starters have been installed in high-profile locations worldwide. By integrating motor protection with soft start and soft stop control, the MVS provides a simple and cost-effective solution for most major applications.

Contact your local AuCom distributor for more information or visit our website [www.aucom.com](http://www.aucom.com).





## PANEL DESIGN FEATURES

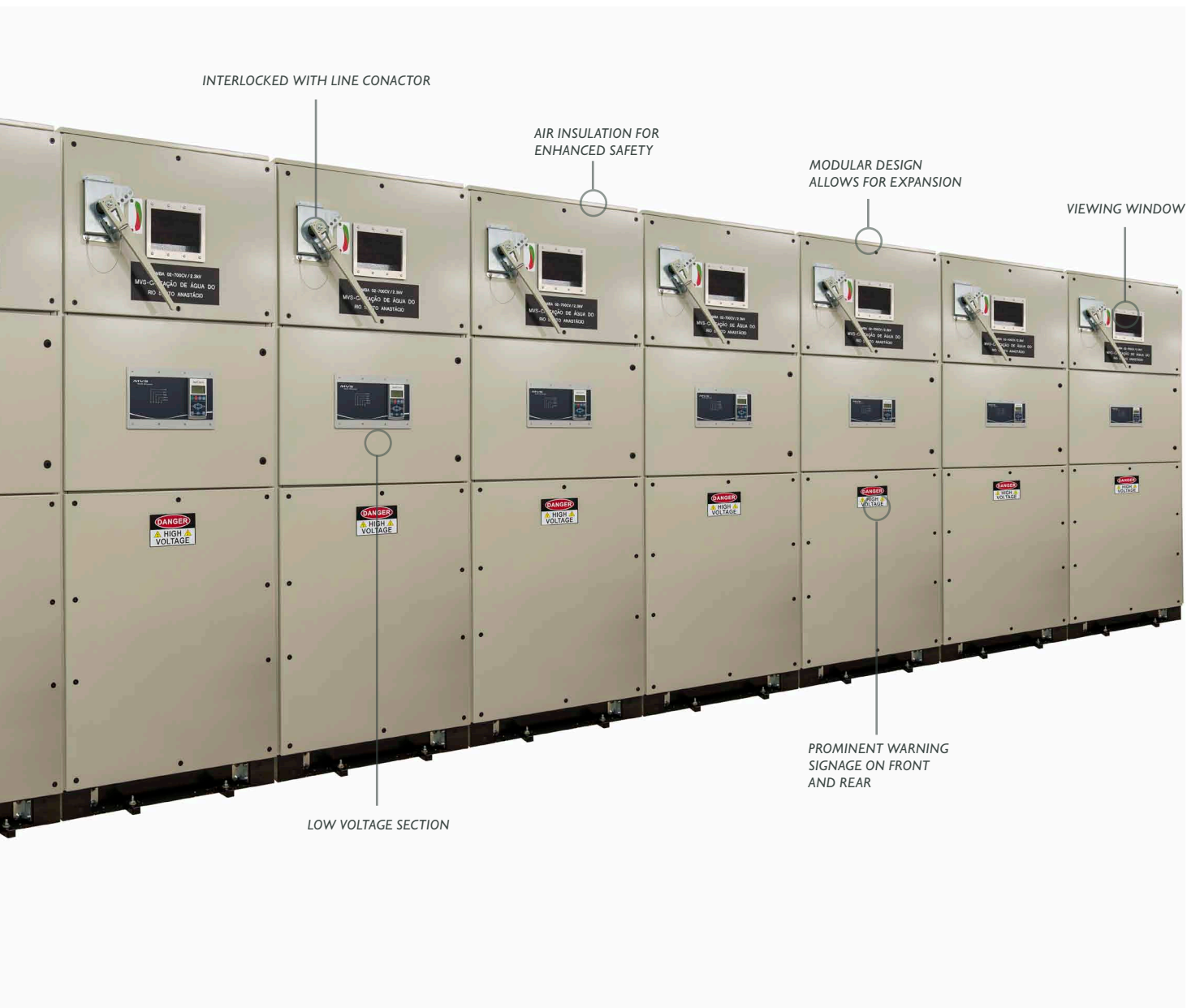



# PANEL DETAILS

## PANELS

MVS soft starters can be installed easily into standard panels to provide a complete motor control cabinet. The compact size of the power assembly leaves room for auxiliary equipment to be installed.



Front view of MVS panel with door open, MVS power assembly is located in lower section.



Side view of MVS panel with panels removed.



Front view of a typical MVS soft starter.

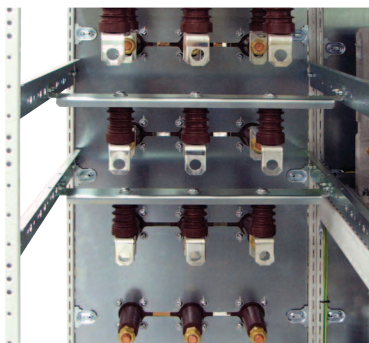

Transition panels may be cabled into or use bus bars.

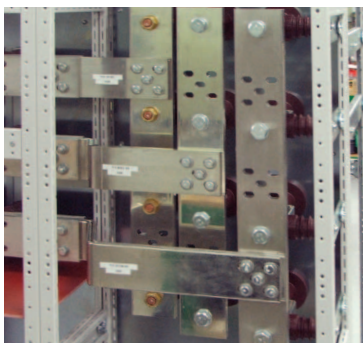

Bus bar detail.

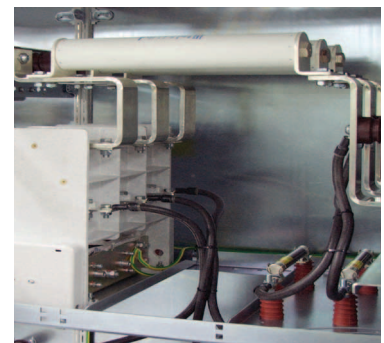

Contactant and fuse detail.

# SAFE

## AIR INSULATION

The MVS incorporates extra features to ensure personnel safety when working in the MV environment. Air insulation assures long-term reliability. The MVS has communication between the low voltage controller and the high voltage power assembly via fibre-optic cables, for complete electrical isolation. Enclosed units designed by AuCom include additional physical isolation and safety interlocks, for maximum safety.

## BUS BAR ISOLATION

Tinned bus bars on the MVS soft starter are located at the rear of the panel. Barriers isolate cables from bus bars to allow inspection of cabling.

## PANEL CONSTRUCTION

MVS panels feature bolted construction to prevent unintentional access. This ensures that covers may only be removed with very deliberate actions. This also removes the need for mechanical interlocking.

## BYPASS TERMINALS

Retains motor protection and monitoring functions even when the starter is bypassed.



*Horizontal bus bars can be engineered throughout the length of your panel. Insulated panels to isolate input and output bars are optional.*



*Generous space in the rear of the cabinet makes cabling your soft starter easy. The MVS has options to cable from either bottom, top, left or right.*



*Lockable door prevents unauthorised access.*

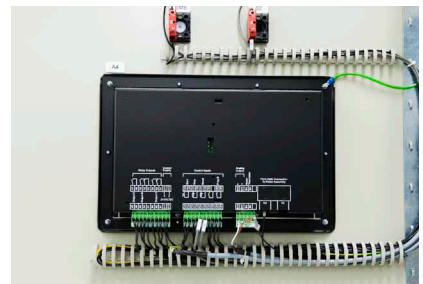

*Fibre-optic cables isolate medium voltage and low voltage sections of the MVS and ensure 100% safety for operating personnel.*

## IP00 DESIGN FEATURES

The MVS power assemblies are very robust and compact, minimising panel space requirements and making MVS soft starters suitable for use in even the most demanding industrial locations.

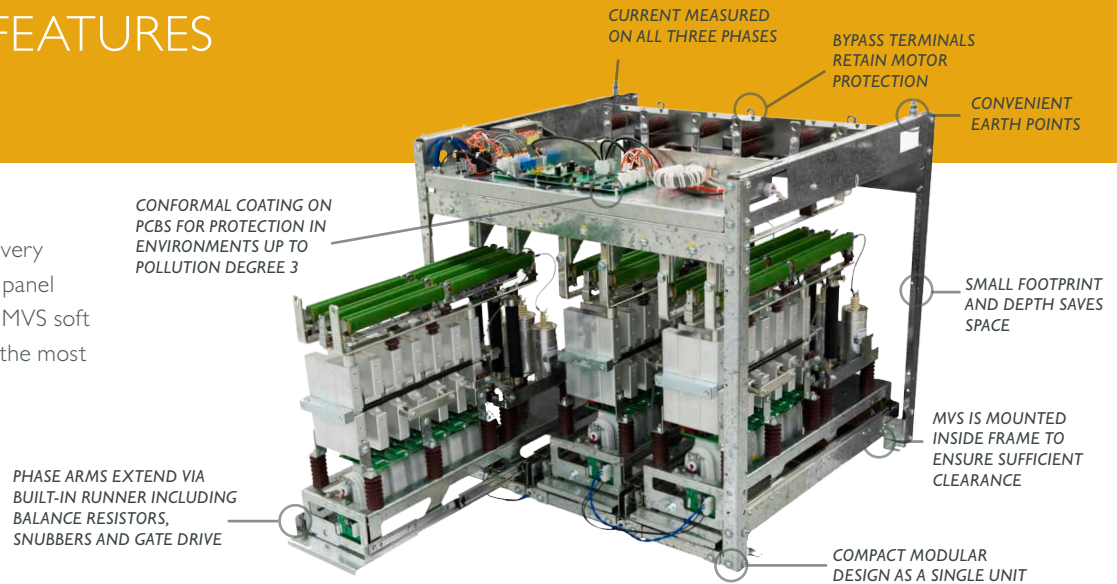

## PRODUCT FEATURES

### STARTING FUNCTIONS

- Acceleration
- Constant current start mode
- Current ramp start mode
- Torque control
- Kickstart

### STOPPING FUNCTIONS

- Deceleration
- TVR soft stop
- Coast to stop

### HUMAN INTERFACE

- Fibre optic link
- Status LEDs
- Event log (99 positions, time stamped)
- User-programmable metering screen
- Multi-level password protection
- Plug-in control terminal blocks
- Multi-language feedback

### PROTECTION

- Fully customisable protection
- Motor thermal model (Thermal Model)
- Motor thermistor input
- Phase sequence
- Undercurrent
- Instantaneous overcurrent
- Auxiliary trip inputs
- Power loss
- Excess start time
- Supply frequency
- Shorted SCR
- Power circuit
- Motor connection
- RS485 failure
- Mains frequency
- Input trip
- Motor overload
- Current imbalance
- Ground fault

(see page 9 for protection codes)

### OTHER

- Dual Motor Sets
- Emergency Start Capability
- Starter Thermal Model
- Trip Log (8 positions, date/time stamped)
- Counters (starts, hours-run, kWh)
- Metering (amperes, volts, power factor, kW, kVA)

### OPTIONAL FEATURES

- Modbus RTU Interface
- Profibus Interface
- DeviceNet Interface
- USB Module
- Synchronous motor control
- PC Software
- Overvoltage protection
- Control supply transformer
- Remote Operator



## PRODUCT RANGE

### MODELS AVAILABLE

- MVS 2.3 kV
- MVS 3.3 kV
- MVS 4.2 kV
- MVS 6.6 kV
- MVS 7.2 kV
- MVS 11.0 kV
- MVS 13.8 kV

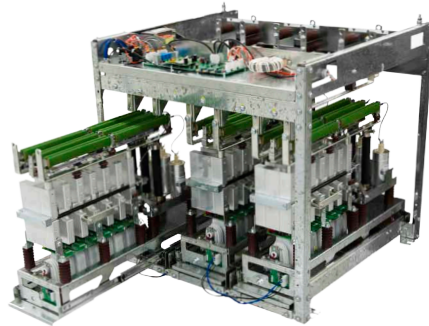

## RATINGS

AuCom selects each MVS to suit your needs. Choose a starter to suit your site conditions such as altitude, ambient temperature, load, and starts per hour.

AuCom MVS ratings are detailed using the AC53b utilisation code. An example is shown below.

**I65 A:AC-53b 5-30 : I770**

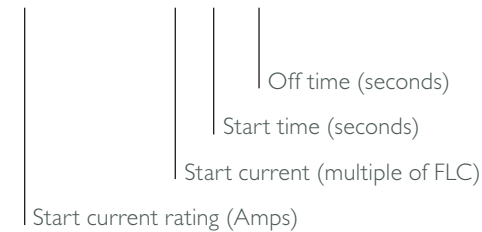

### STARTER CURRENT RATING

The full load current rating of the soft starter given the parameters detailed in the remaining sections of the utilisation code.

### START CURRENT

The maximum available start current as a multiple of FLC.

### START TIME

The maximum time required to start the motor at the rated start current.

### OFF TIME

The minimum allowable time between the end of one start and the beginning of the next start.



# SPECIFICATIONS

## General

Current Range ..... 50 A ~ 600 A (nominal)\*  
 Motor connection ..... In-line

## Supply

Mains Voltage (L1, L2, L3)  
 MVSxxxx-V02 ..... 3 x 2300 VAC (± 10%)  
 MVSxxxx-V03 ..... 3 x 3300 VAC (± 10%)  
 MVSxxxx-V04 ..... 3 x 4160 VAC (± 10%)  
 MVSxxxx-V06 ..... 3 x 6600 VAC (± 10%)  
 MVSxxxx-V07 ..... 3 x 7200 VAC (± 10%)  
 MVSxxxx-V11 ..... 3 x 11000 VAC (± 10%)  
 MVSxxxx-V13 ..... 3 x 13800 VAC (± 10%)  
 Control Voltage (A1, A2, A3) ..... 110 VAC to 130 VAC (+10% /-15%)  
 ..... or 220 VAC to 240 VAC (+10% /-15%)  
 Mains Frequency ..... 45 Hz to 66 Hz

## Inputs

Inputs ..... Active 24 VDC, 8 mA approx.  
 Start (C23, C24) ..... 24 VDC, 8mA approx.  
 Stop (C31, C32) ..... 24 VDC, 8mA approx.  
 Reset (C41, C42) ..... 24 VDC, 8mA approx.  
 Input A (C53, C54) ..... 24 VDC, 8mA approx.  
 Input B (C63, C64) ..... 24 VDC, 8mA approx.  
 Motor Thermistor (B4, B5)

## Outputs

Relay outputs ..... 10 A at 250 VAC/360 VA  
 ..... 10 A at 30 VAC resistive  
 Main Contactor (Terminals 13, 14) ..... Normally Open  
 Bypass Contactor (Terminals 23, 24) ..... Normally Open  
 Run Output/ PFC (Terminals 33, 34) ..... Normally Open  
 Output Relay A (Terminals 43, 44) ..... Normally Open  
 Output Relay B (Terminals 51, 52, 54) ..... Changeover  
 Output Relay C (Terminals 61, 62, 64) ..... Changeover  
 Analog Output (Terminals B10, B11) ..... 0-20 mA or 4-20 mA

## Environmental

Protection  
 Power Assembly ..... IP00  
 Controller ..... IP54/ NEMA 12  
 Operating Temperature ..... - 10 °C to + 55 °C  
 Storage Temperature ..... - 25 °C to + 55 °C  
 Conformal coating of PCBs ..... Standard

\* Ratings higher than 600A available on request.

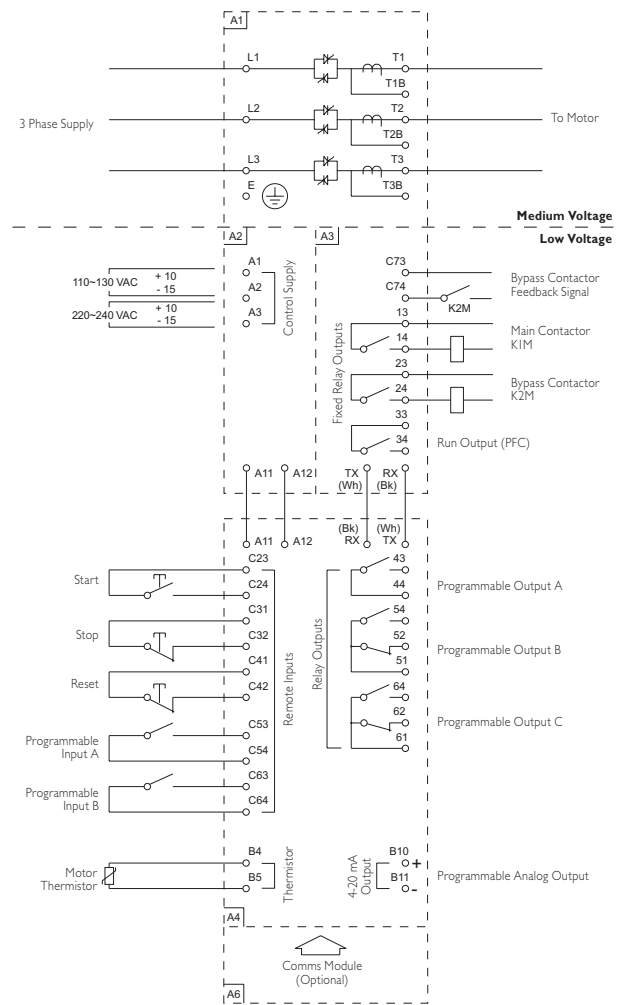

Item	Description
A1	Power Assembly
A2	Control Voltage Terminal Block
A3	Power Interface PCB
A4	Controller
A6	Comms Module (Optional)
K1M	Main Contactor
K2M	Bypass Contactor







# PROTECTION

## PROTECTION

A wide range of protection features ensure your equipment can operate safely in the most demanding environments. Each protection can be individually adjusted to the required sensitivity, or can be disabled if required to ensure vital equipment continues to operate even in the most challenging situations.

## ADVANCED THERMAL MODELLING

Intelligent thermal modelling allows the soft starter to dynamically calculate motor temperature to predict whether the motor can successfully complete a start. The MVS uses information from previous and upcoming starts to calculate the motor temperature to predict the motor's available thermal capacity.

## THERMAL CAPACITY

The thermal model will only permit a start which is predicted to succeed. This protects the motor against overloads which shorten the motor life.

## TRIPS

Trips and warnings are written to an eight-place trip log, together with information on motor and system status at the time, speeding up analysis of problems.

## PASSWORD PROTECTION

A multi-level password system provides security for parameter adjustments while still allowing users full access to the many metering functions.

## PROTECTION CODES

ANSI Code	Description	MVS Protection (built-in)
48	Maximum start time	Excess start time
66	Too many starts	Restart delay and dynamic thermal model
37	Undercurrent	Undercurrent
51L	Load Increase (alarm)	High current frequency output
51R	Overcurrent - jam	Excess start time, electronic shearpin
50	Overcurrent - short	Shorted SCR, electronic shearpin
49/51	Thermal overload	Thermal overload - dynamic model
46	Current imbalance	Current imbalance
	Positive/negative phase sequence	Phase sequence
27	Undervoltage	Undervoltage
59	Overvoltage	Overvoltage
47	Phase loss	Phase loss
47	Phase sequence	Phase sequence
50G	Ground fault	Ground fault
85	Communications failure	Communications failure
85	Internal failure	Internal failure
94/95	Ext. fault 1/code - 1	Auxiliary trip A
	Ext. fault 1/code - 2	Auxiliary trip B
23	Motor overtemperature	Thermistor protection*
49	Stator winding overtemperature	Thermistor protection*
32	Under power	Power Loss

\* RTD Relay is an optional extra.

## COMMUNICATION MODULES



The MVS integrates into your existing monitoring and control network, using easy-to-install plug-in communication interfaces. The MVS supports Profibus, DeviceNet and Modbus RTU protocols. Communication modules are an optional extra.

## FIBRE OPTICS

Electrical isolation of low and high voltage circuits is assured by a two line fibre-optic interface between the power assembly and the control module. This fibre-optic link simplifies installation of chassis mount MVS units into custom switchboards.



# KEYPAD DISPLAY

## EASY TO READ SCREEN

The MVS has a real-language display, offering extensive feedback and real-time status information in an easy-to-read format.

Comprehensive metering information, details of starter status and last start performance allow easy monitoring of the starter's performance at all times

Multiple status screens let you display the data most relevant to your application, or you can configure your own programmable screen to show the most relevant information for your application.

## REMOTE DISPLAY MOUNTING

The controller can be mounted on the exterior of the panel reducing the need for separate meters and status indicators.

## LANGUAGES

- English, Chinese, Español, Deutsch, Português, Français, Italiano, Russian

## EVENT LOGS

A 99 position event log records all information on the starter's operating history, in separate event and trip logs to assist in trouble-shooting. An eight position trip log records trip states and operating conditions at the time of trip.

- Phase currents at time of trip
- Phase voltages at time of trip
- Mains frequency at time of trip
- Starter state at time of trip
- Time and date of trip

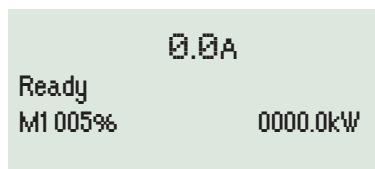

Starter status including current and FLC



Line Voltages and Currents (L1, L2, L3)

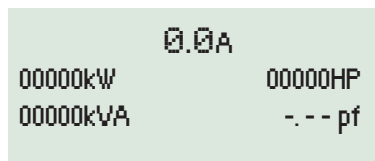

Power metering

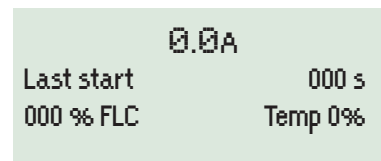

Last Start Information

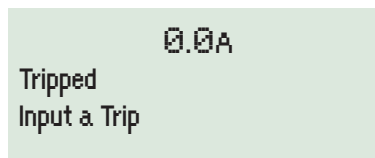

Full text trip messages

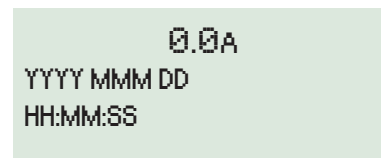

Date & Time

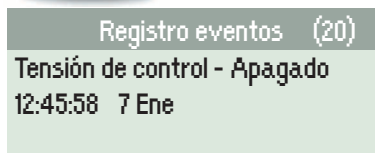

Control power turned off

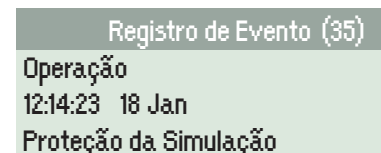

Protection simulation performed

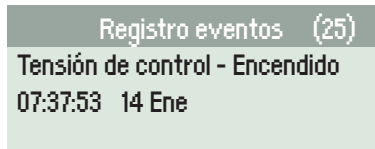

Power restored to the starter

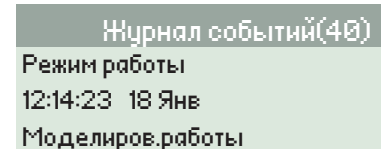

Run simulation performed



Load default operation performed

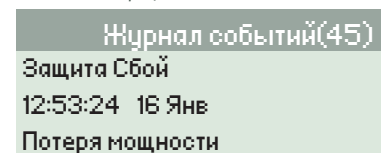

Notification of trip - power loss



# STARTING AND STOPPING MODES

## CONSTANT CURRENT

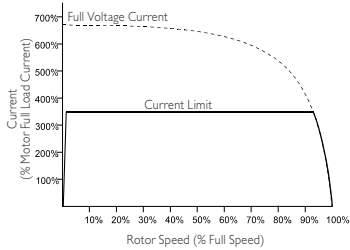

Suitable for most applications. Current is raised to specified level and held for duration of start.

## CURRENT RAMP

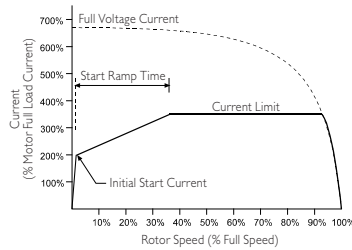

Better for generator sets or if conditions may vary between starts.

## KICKSTART

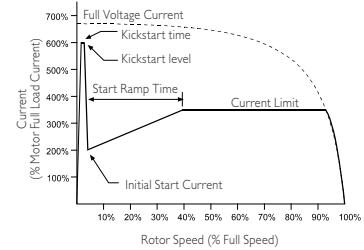

Provides a short boot of torque at the beginning of the start.

## COAST TO STOP

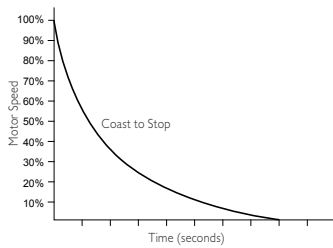

Removes voltage from motor and allows inertial slowing.

## TIMED VOLTAGE RAMP

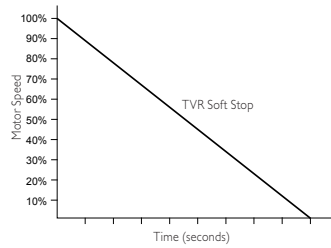

Gradually reduces voltage to extend deceleration time.



## ENCLOSURES

MVS enclosures are engineered to suit your project specific requirements. For other options, please contact your local sales engineer for more information.

Some examples of enclosure options include:

- Powerfactor correction
- Additional motor protection relays
- Transition panels with cables or direct bus bar connections
- Multi-motor operation
- Top of bottom entry cabling
- Various control options and RTD relays.

Enclosure*	A	B	C	D	E
	mm (inches)	mm (inches)	mm (inches)	mm (inches)	mm (inches)
MVS 3.3/4.2	2322 (91.42)	2222 (87.48)	844 (33.23)	1244 (47.24)	1337 (57.64)
MVS 6.6/7.2	2322 (91.42)	2222 (87.48)	1044 (41.10)	1244 (47.24)	1337 (57.64)
MVS 11/13	Ask your sales engineer for details				

\* Measurements shown are typical dimensions and may vary for specific projects.

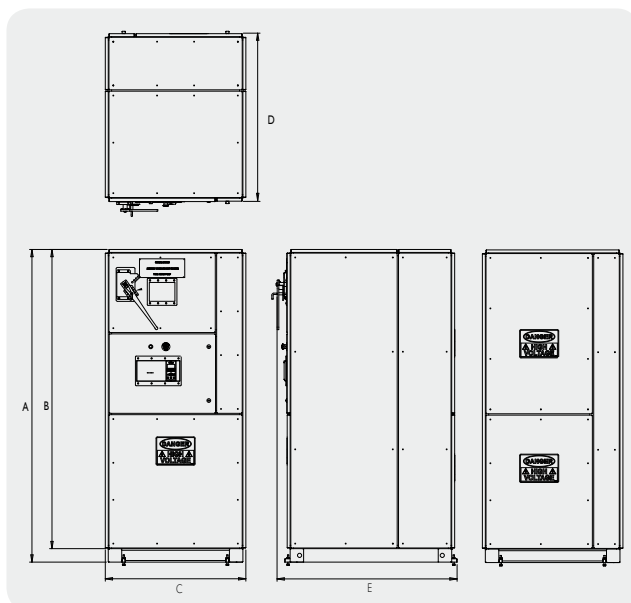

MVS 3.3-7.2

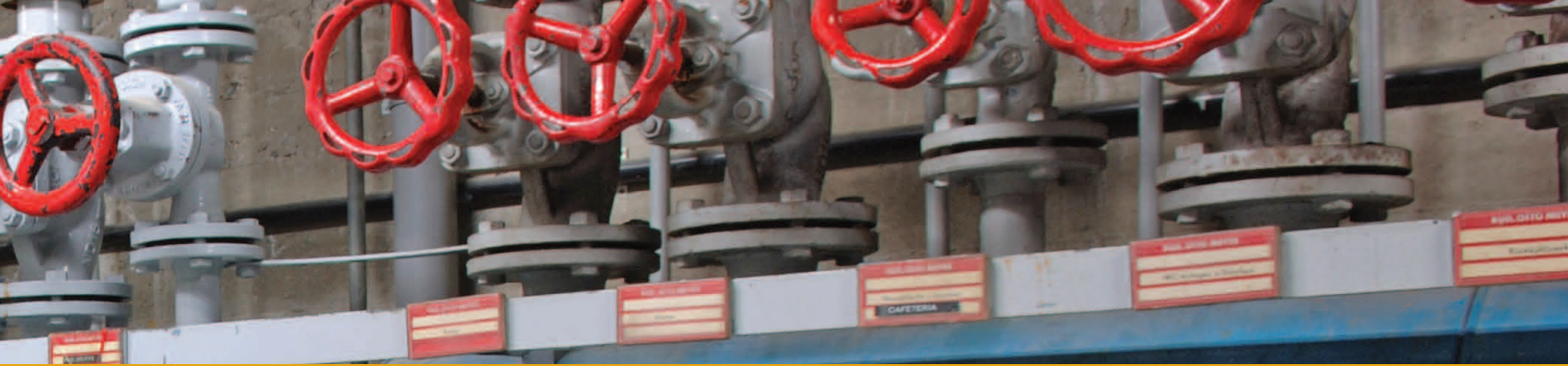

## DIMENSIONS AND WEIGHTS

IP00 Model	A	B	C	Weight
	mm (inches)	mm (inches)	mm (inches)	kg (lbs)
MVSxxxx-V02	772	669	667	165
MVSxxxx-V03	(30.4)	(26.3)	(26.3)	(363.8)
MVSxxxx-V04				
MVSxxxx-V06	832	875	817	217
MVSxxxx-V07	(32.8)	(34.5)	(32.2)	(478.4)
MVSxxxx-V11	2140	1150	1150	700
	(84.3)	(45.3)	(45.3)	(1540)
MVSxxxx-V13	2140	1150	1150	700
	(84.3)	(45.3)	(45.3)	(1540)

Front View

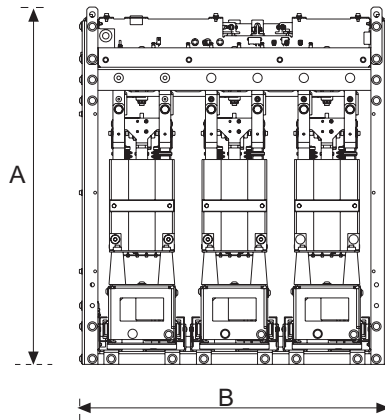

Side View

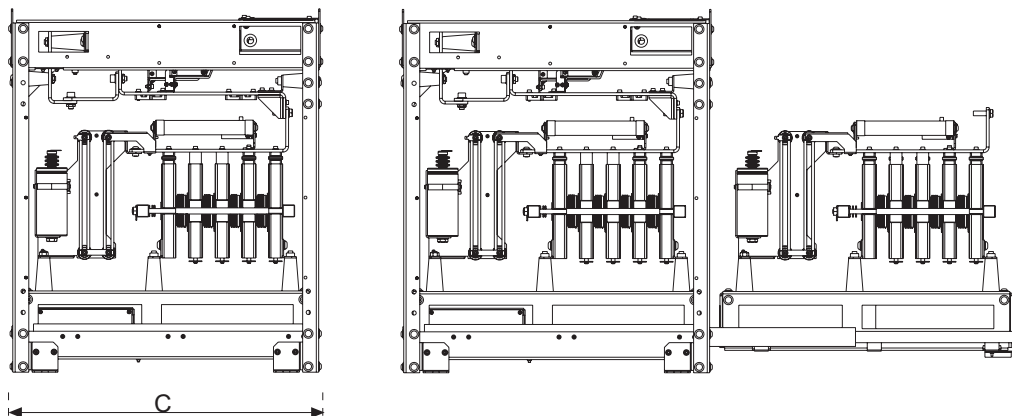



## COMMISSIONING

### COMMISSIONING

AuCom makes medium voltage installation and commissioning simple without unnecessary interruption to your normal operation. For minimal disruption, the MVS incorporates extensive operating simulations and allows the starter to be tested with a low voltage motor, to confirm circuit integrity and identify any errors before full commissioning. As well as comprehensive run simulations, the MVS can simulate each protection to ensure the starter is signalling as expected and interacting correctly with associated equipment.

### SOFTWARE SIMULATIONS

The simulation function allows the MVS to be tested without a motor connected, to confirm that the soft starter's control circuits are operating correctly. There are three simulation modes available:

- Run simulation: simulates a motor starting, running and stopping to confirm correct configuration of main and bypass contactors, fibre-optic controls, programmable relays and motor control signals.
- Protection simulation: simulates activation of each protection mechanism to confirm that the soft starter is responding correctly in each situation.
- Signalling simulation: simulates output signalling to confirm configuration.

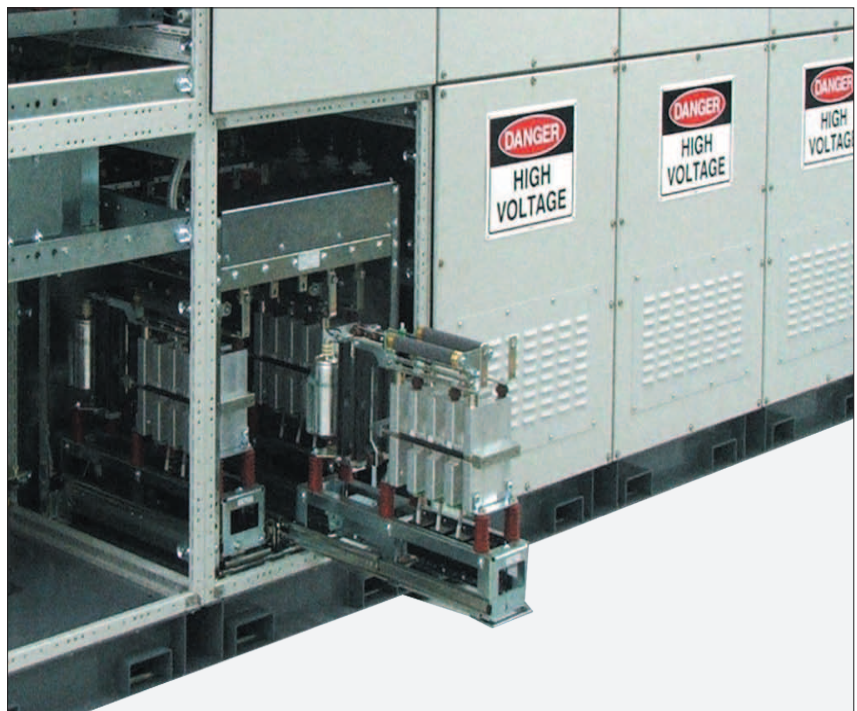

*Phase arms slide out easily on built-in runners. The MVS has been designed to make installation, maintenance and operation a breeze.*

### LOW VOLTAGE TESTING

The MVS can be connected to a low voltage motor ( $\leq 500$  VAC) for testing. This allows the user to thoroughly test the soft starter and its associated power and control circuits. The low voltage test mode provides a means of testing the soft starter's configuration without requiring a full medium voltage test facility.

### DIRECT ON-LINE

Many customisable MV units are equipped with a DOL feature. This allows DOL motor operation in the event of failure to maximise uptime during repair.

### AFTER SALES SERVICE

Annual maintenance contracts and other after sales service packages may be included with your project, ask your sales engineer for more information.



## ABOUT AUCOM

### THE SOFT START SPECIALISTS

AuCom is totally focused on soft starters, with a range of industry leading products utilising the latest technology.

A dedicated medium voltage laboratory with full manufacturing and testing on-site facility provides selectable voltage sources from 2.3kV to 13.8kV, pump load, electronically controlled test load and synchronous motor testing capabilities.

Our customers benefit from our years of experience and will assist you to ensure a successful commissioning of your MVS soft starter.

For more information about our MVS soft starter contact your local sales engineer or visit [www.aucom.com](http://www.aucom.com)



*AuCom's medium voltage testing facility*

# OTHER AUCom PRODUCTS

AuCom offers a complete range of soft starters, with a solution for your soft starting requirement. Whether you need a simple product for starting only, or a comprehensive solution for your motor control and protection needs, you can trust AuCom to offer a product to match.

	Soft Start	Motor Protection	Advanced Interface	Internal Bypass	Power Range	Voltage Range
CSX	•			•	≤ 200 A	≤ 575 VAC
CSXi	•	•		•	≤ 200 A	≤ 575 VAC
IMS2	•	•	•		≤ 2361 A	≤ 690 VAC
EMX3	•	•	•	•	≤ 2400 A	≤ 690 VAC
MVX	•	•	•	•	≤ 800 A *	≤ 15 kV
MVD	•	•	•	•	≤ 800 A *	≤ 13.8 kV

\* Higher ratings available on request.

## CSXi COMPACT SOFT STARTER



A compact soft starter providing constant current soft start control and essential motor protection. A complete motor control solution in a single compact design.

## EMX3 ADVANCED SOFT STARTER



A complete motor management system providing constant current, and current ramp as well as the new XLR-8, Adaptive Acceleration Control, available only from AuCom.

## MVX SOFT STARTER



A comprehensive motor management system providing selectable soft start and soft stop control, advanced motor/load protection systems and extensive control & interface features.

## MVD VARIABLE FREQUENCY DRIVE



An advanced medium voltage drive offering many technical benefits: reduced energy costs, lower stress on motor terminals, cases and bearings all whilst providing a cleaner waveform to the motor.

For more information on AuCom products, contact your local distributor:

# AuCom

**AuCom Electronics Ltd.**

123 Wrights Road  
PO Box 80208  
Christchurch 8440  
New Zealand

**T** +64 3 338 8280

**F** +64 3 338 8104

**E** [salesupport@aucom.com](mailto:salesupport@aucom.com)

**W** [www.aucom.com](http://www.aucom.com)

© 2011 AuCom Electronics. As AuCom is continuously improving its products it reserves the right to modify or change the specification of its products at any time without notice. The text, diagrams, images and any other literary or artistic works appearing in this brochure are protected by copyright. Users may copy some of the material for their personal reference but may not copy or use material for any other purpose without the prior consent of AuCom Electronics Ltd. AuCom endeavours to ensure that the information contained in this brochure including images is correct but does not accept any liability for error, omission or differences with the finished product.