



User Manual for eXL10 OCS

MAN1029-01-EN

HE-EXV1E0 / HEXT505C100
HE-EXV1E2 / HEXT505C112
HE-EXV1E3 / HEXT505C113
HE-EXV1E4 / HEXT505C114
HE-EXV1E5 / HEXT505C115
HE- EXV1E6 / HEXT505C116



PREFACE

This manual explains how to use the EXL10 OCS.

Copyright© 2013 Horner APG, LLC, 59 South State Avenue, Indianapolis, Indiana 46201. All rights reserved. No part of this publication may be reproduced, transmitted, transcribed, stored in a retrieval system, or translated into any language or computer language, in any form by any means, electronic, mechanical, magnetic, optical, chemical, manual or otherwise, without the prior agreement and written permission of Horner APG, Inc.

All software described in this document or media is also copyrighted material subject to the terms and conditions of the Horner Software License Agreement.

Information in this document is subject to change without notice and does not represent a commitment on the part of Horner APG.

Ethernet™ is a trademark of Xerox Corporation.

MicroSD™ and CompactFlash are registered trademarks of SanDisk Corporation.

For user manual updates, contact Technical Support:

North America:

Tel: (+) (317) 916-4274

Fax: (+) (317) 639-4279

Web: <http://www.heapg.com>

Email: techspt@heapg.com

Europe:

Tel: (+) 353-21-4321-266

Fax: (+) 353-21-4321-826

Web: <http://www.horner-apg.com>

Email: tech.support@horner-apg.com

LIMITED WARRANTY AND LIMITATION OF LIABILITY

Horner APG, LLC, ("HE-APG") warrants to the original purchaser that the EXL10 (HE-XW/HEXT391) OCS module manufactured by HE-APG is free from defects in material and workmanship under normal use and service. The obligation of HE-APG under this warranty shall be limited to the repair or exchange of any part or parts which may prove defective under normal use and service within two (2) years from the date of manufacture or eighteen (18) months from the date of installation by the original purchaser whichever occurs first, such defect to be disclosed to the satisfaction of HE-APG after examination by HE-APG of the allegedly defective part or parts. THIS WARRANTY IS EXPRESSLY IN LIEU OF ALL OTHER WARRANTIES EXPRESSED OR IMPLIED INCLUDING THE WARRANTIES OF MERCHANTABILITY AND FITNESS FOR USE AND OF ALL OTHER OBLIGATIONS OR LIABILITIES AND HE-APG NEITHER ASSUMES, NOR AUTHORIZES ANY OTHER PERSON TO ASSUME FOR HE-APG, ANY OTHER LIABILITY IN CONNECTION WITH THE SALE OF THIS EXL10 OCS module. THIS WARRANTY SHALL NOT APPLY TO THIS EXL10 OCS module OR ANY PART THEREOF WHICH HAS BEEN SUBJECT TO ACCIDENT, NEGLIGENCE, ALTERATION, ABUSE, OR MISUSE. HE-APG MAKES NO WARRANTY WHATSOEVER IN RESPECT TO ACCESSORIES OR PARTS NOT SUPPLIED BY HE-APG. THE TERM "ORIGINAL PURCHASER", AS USED IN THIS WARRANTY, SHALL BE DEEMED TO MEAN THAT PERSON FOR WHOM THE EXL10 OCS module IS ORIGINALLY INSTALLED. THIS WARRANTY SHALL APPLY ONLY WITHIN THE BOUNDARIES OF THE CONTINENTAL UNITED STATES.

In no event, whether as a result of breach of contract, warranty, tort (including negligence) or otherwise, shall HE-APG or its suppliers be liable of any special, consequential, incidental or penal damages including, but not limited to, loss of profit or revenues, loss of use of the products or any associated equipment, damage to associated equipment, cost of capital, cost of substitute products, facilities, services or replacement power, down time costs, or claims of original purchaser's customers for such damages.

To obtain warranty service, return the product to your distributor with a description of the problem, proof of purchase, postpaid, insured and in a suitable package.

ABOUT PROGRAMMING EXAMPLES

Any example programs and program segments in this manual or provided on accompanying diskettes are included solely for illustrative purposes. Due to the many variables and requirements associated with any particular installation, Horner APG cannot assume responsibility or liability for actual use based on the examples and diagrams. It is the sole responsibility of the system designer utilizing the eXL10 OCS module to appropriately design the end system, to appropriately integrate the eXL10 OCS module and to make safety provisions for the end equipment as is usual and customary in industrial applications as defined in any codes or standards which apply.

Note: The programming examples shown in this manual are for illustrative purposes only. Proper machine operation is the sole responsibility of the system integrator.

INTENTIONALLY LEFT BLANK

TABLE OF CONTENTS

PREFACE	3
For user manual updates, contact Technical Support:.....	3
LIMITED WARRANTY AND LIMITATION OF LIABILITY	4
ABOUT PROGRAMMING EXAMPLES	4
TABLE OF CONTENTS	6
CHAPTER 1: SAFETY / COMPLIANCE	12
1.1 Safety Warnings and Guidelines	12
1.2 Grounding	13
1.3 CE Compliance	13
CHAPTER 2: INTRODUCTION	14
2.1 Visual Overview of eXL10 OCS	14
2.1.1 <i>Where to Find Information about the eXL10 OCS</i>	14
2.1.2 <i>Four main types of information are covered in the manual</i>	14
2.1.3 <i>Manual Index</i>	15
2.1.4 <i>Table of Figures</i>	15
2.2 Connectivity to the eXL10 OCS	15
2.3 Features of eXL10 OCS.....	15
2.4 Required and Suggested Accessories.....	16
2.5 Useful Documents and References.....	16
CHAPTER 3: MECHANICAL INSTALLATION	17
3.1 Overview	17
3.2 Mounting Requirements.....	17
3.2.1 <i>Mounting Procedures (Installed in a Panel Door)</i>	17
3.3 Mounting Orientation.....	18
3.3.1 <i>eXL10 OCS Mounting Clip</i>	18
3.3.2 <i>eXL10 OCS Mounting Orientation</i>	18
3.4 Panel Cut-Out.....	19
3.5 eXL10 Dimensions.....	19
3.6 Factors Affecting Panel Layout Design and Clearances	19
3.6.1 <i>Clearance / Adequate Space</i>	19
3.6.2 <i>Grounding</i>	19
3.6.3 <i>Temperature / Ventilation</i>	19
3.6.4 <i>Orientation</i>	19
3.6.5 <i>Noise</i>	20
3.6.6 <i>Shock and Vibration</i>	21
3.6.7 <i>Panel Layout Design and Clearance Checklist</i>	21
CHAPTER 4: ELECTRICAL INSTALLATION	23
4.1 Grounding Definition	23
4.2 Ground Specifications	23
4.3 How to Test for Good Ground	23
4.4 Primary Power Port.....	24

CHAPTER 5: SERIAL COMMUNICATIONS..... 25

5.1 Overview 25

5.2 Port Descriptions..... 25

5.3 Wiring and Dip Switches 25

5.4 RS485 Termination..... 26

5.5 RS485 Biasing 26

5.6 Cscape Programming via Serial Port 26

5.7 Ladder-Controlled Serial Communication..... 26

5.8 Downloadable Serial Communication Protocols 26

CHAPTER 6: CAN COMMUNICATIONS 27

6.1 Overview 27

6.2 Port Description 27

6.3 CAN Port Wiring 27

6.4 Cscape Programming via CAN..... 28

6.5 Ladder-Controlled CAN Communication 29

6.6 Using CAN for I/O Expansion (Network I/O) 29

CHAPTER 7: ETHERNET COMMUNICATION 30

7.1 Ethernet Module Protocols and Features..... 30

7.2 Ethernet System Requirements 30

7.3 Ethernet Module Specifications..... 30

7.4 Ethernet Module Configuration..... 30

CHAPTER 8: COMMUNICATION OPTIONS 35

8.1 Overview 35

8.2 Modem COM Module (XMC) Option 35

CHAPTER 9: REMOVABLE MEDIA 36

9.1 Overview 36

9.2 MicroSD Cards..... 36

9.3 MicroSD File System..... 36

9.4 Using the Removable Media Manager 37

9.5 Using Removable Media to Log Data..... 37

9.6 Using Removable Media to Load and Save Applications 37

9.7 Using Removable Media to View and Capture Screens..... 38

9.8 Removable Media (RM) Function Blocks in Cscape 38

9.9 Filenames used with the Removable Media (RM) Function Blocks..... 36

9.10 System Registers used with RM 37

CHAPTER 10: GENERAL I/O 38

10.1 Overview 38

10.2 Removing the EXL10 OCS I/O Cover 38

10.3 Model and I/O Overview..... 42

10.4 Solid-State Digital Outputs..... 42

10.5 Relay Outputs..... 43

10.6 Digital Inputs 44

10.7 Analog Inputs 44

 10.7.1 *Common cause of analog input tranzorb failure* 43

10.8 Universal Analog Inputs 45

10.9 Analog Outputs 45

CHAPTER 11: HIGH SPEED I/O (HSC / PWM)	47
11.1 Overview	47
11.2 Glossary.....	47
11.3 High Speed Counter (HSC) Functions.....	45
11.3.1 Frequency	45
11.3.2 Totalize	45
11.3.3 Pulse Width Measurement	45
11.3.4 Period Measurement.....	46
11.3.5 Quadrature	47
11.3.6 Register Match	47
11.4 HSC Functions Register Map.....	47
11.5 High Speed Output Functions	48
11.5.1 Normal.....	49
11.5.2 PWM.....	49
11.5.3 HSC Output (High Speed Counter Match).....	52
11.5.4 Stepper Function.....	53
11.6 PWM functions register map	54
11.7 PWM Examples	54
11.8 STP Examples	55
CHAPTER 12: SYSTEM SETTINGS AND ADJUSTMENTS	56
12.1 System Menu - Overview	56
12.2 System Menu – Navigation and Editing.....	53
12.3 System Menu – Details	54
12.4 Touch screen calibration.....	64
CHAPTER 13: USER INTERFACE	65
13.1 Overview	65
13.2 Displaying and entering Data.....	65
13.3 Alpha-numeric keypad	66
13.4 Screen Navigation	67
13.5 Ladder Based Screen Navigation	68
13.6 Beeper Acknowledgement.....	68
13.7 Touch (Slip) Sensitivity	68
13.8 Alarms	69
13.9 Removable Media	73
13.10 Screen Saver	71
13.11 Screen Brightness	72
CHAPTER 14: REGISTERS	74
14.1 Register Definitions.....	74
14.2 Useful %S and %SR registers.....	74
14.3 Register Map for EXL10 OCS I/O	77
14.4 Resource Limits	77
CHAPTER 15: CSCAPE CONFIGURATION	79
15.1 Overview	79
15.2 Cscape Status Bar.....	79
15.3 Establishing Communications	82
15.3.1 Communicating via MJ1 Serial Port	83

- 15.3.2 *Communicating via On Board Ethernet Port* 84
- 15.5 Configuration 85
- 15.6 Digital Input / HSC Configuration..... 85
- 15.7 Digital Output / PWM Configuration 86
- 15.8 Analog Input Configuration..... 87
- 15.9 Analog Output Configuration..... 88
- CHAPTER 16: FAIL-SAFE SYSTEM 89**
 - 16.1 Overview..... 89
 - 16.2 Settings..... 89
 - 16.3 Backup / Restore Data 93
 - 16.4 AutoLoad..... 93
 - 16.5 AutoRun 95
- CHAPTER 17: CLONE UNIT..... 96**
 - 17.1 Overview 96
 - 17.2 Clone: 96
 - 17.3 Load Clone..... 98
- CHAPTER 18: MAINTENANCE 103**
 - 18.1 Firmware Updates..... 103
 - 18.2 Backup Battery..... 103
 - 18.2.1 *Indications the battery needs replacing* 100
- CHAPTER 19: TROUBLESHOOTING / TECHNICAL SUPPORT 106**
 - 19.1 Connecting to the EXL10 OCS 106
 - 19.1.1 *Connecting Troubleshooting Checklist (serial port – MJ1 Programming)* 107
 - 19.1.2 *Connecting Troubleshooting Checklist (USB Port - Mini B Programming)* 107
 - 19.1.3 *Connecting Troubleshooting Checklist (ETN port programming)*..... 107
 - 19.2 Local Controller and Local I/O..... 107
 - 19.2.1 *Local I/O Troubleshooting Checklist* 108
 - 19.3 CsCAN Network..... 108
 - 19.3.1 *CsCAN Network Troubleshooting Checklist* 108
 - 19.4 Removable Media 109
 - 19.5 Technical Support Contacts 109
 - Main Index..... 110
 - Index of Figures & Tables 113

Visual map of major tasks and the key chapters to assist you

FIRST STEP of ANY TASK: DATASHEET			
<p>Each eXL10 OCS unit is sent with a datasheet in the box. The datasheet (MAN1028-02-EN) is the first document to refer to for model-specific information related to eXL10 OCS models such as pin-outs, jumper settings, and other key installation information. To obtain updates to datasheets, manuals and user documentation, visit a Horner website (US: http://www.heapg.com and Europe: http://www.horner-apg.com.)</p>			
QUICK START	INSTALLATION	PROGRAMMING	TROUBLESHOOTING
Safety / Compliance page 11	Safety / Compliance page 11	Safety / Compliance page 11	Safety / Compliance page 11
Introduction page 13	Introduction page 13	Introduction page 13	Introduction page 13
	Mechanical Installation page 16	Serial Communications page 24	Maintenance page 100
	Electrical Installation page 22	CAN Communications page 26	Troubleshooting page 102
		Ethernet page 28	
		Communication Options page 33	
		Removable Media page 34	
		High Speed I/O page 44	
		System Settings page 53	
		User Interface page 65	
		Registers page 74	
		Cscape Configuration page 79	
		Fail- Safe System page 89	
		Clone Unit page 96	

INTENTIONALLY LEFT BLANK

CHAPTER 1: SAFETY / COMPLIANCE

1.1 Safety Warnings and Guidelines

When found on the product, the following symbols specify:



Warning: Consult user documentation.



Warning: Electrical Shock Hazard.

WARNING – EXPLOSION HAZARD – Do not disconnect equipment unless power has been switched off or the area is known to be non-hazardous

WARNING: To avoid the risk of electric shock or burns, always connect the safety (or earth) ground before making any other connections.

WARNING: To reduce the risk of fire, electrical shock, or physical injury it is strongly recommended to fuse the voltage measurement inputs. Be sure to locate fuses as close to the source as possible.

WARNING: Replace fuse with the same type and rating to provide protection against risk of fire and shock hazards.

WARNING: In the event of repeated failure, do not replace the fuse again as a repeated failure indicates a defective condition that will not clear by replacing the fuse.

WARNING – EXPLOSION HAZARD – Substitution of components may impair suitability for Class I, Division 2

WARNING - The USB parts are for operational maintenance only. Do not leave permanently connected unless area is known to be non-hazardous

WARNING – EXPLOSION HAZARD - BATTERIES MUST ONLY BE CHANGED IN AN AREA KNOWN TO BE NON-HAZARDOUS

WARNING - Battery May Explode If Mistreated. Do Not Recharge, Disassemble or Dispose Of In Fire

WARNING: Only qualified electrical personnel familiar with the construction and operation of this equipment and the hazards involved should install, adjust, operate, or service this equipment. Read and understand this manual and other applicable manuals in their entirety before proceeding. Failure to observe this precaution could result in severe bodily injury or loss of life.

- a. All applicable codes and standards need to be followed in the installation of this product.
- b. For I/O wiring (discrete), use the following wire type or equivalent: Belden 9918, 18 AWG or larger.

Adhere to the following safety precautions whenever any type of connection is made to the module.

- a. Connect the green safety (earth) ground first before making any other connections.
- b. When connecting to electric circuits or pulse-initiating equipment, open their related breakers. Do not make connections to live power lines.
- c. Make connections to the module first; then connect to the circuit to be monitored.
- d. Route power wires in a safe manner in accordance with good practice and local codes.
- e. Wear proper personal protective equipment including safety glasses and insulated gloves when making connections to power circuits.
- f. Ensure hands, shoes, and floors are dry before making any connection to a power line.
- g. Make sure the unit is turned OFF before making connection to terminals. Make sure all circuits are de-energized before making connections.

- h. Before each use, inspect all cables for breaks or cracks in the insulation. Replace immediately if defective.

1.2 Grounding

Grounding is covered in various chapters within this manual.

1.3 Compliance

To check for compliance and updates, visit the Horner website (US: <http://www.heapg.com> or Europe: <http://www.horner-apg.com>.)

CHAPTER 2: INTRODUCTION

2.1 Visual Overview of eXL10 OCS

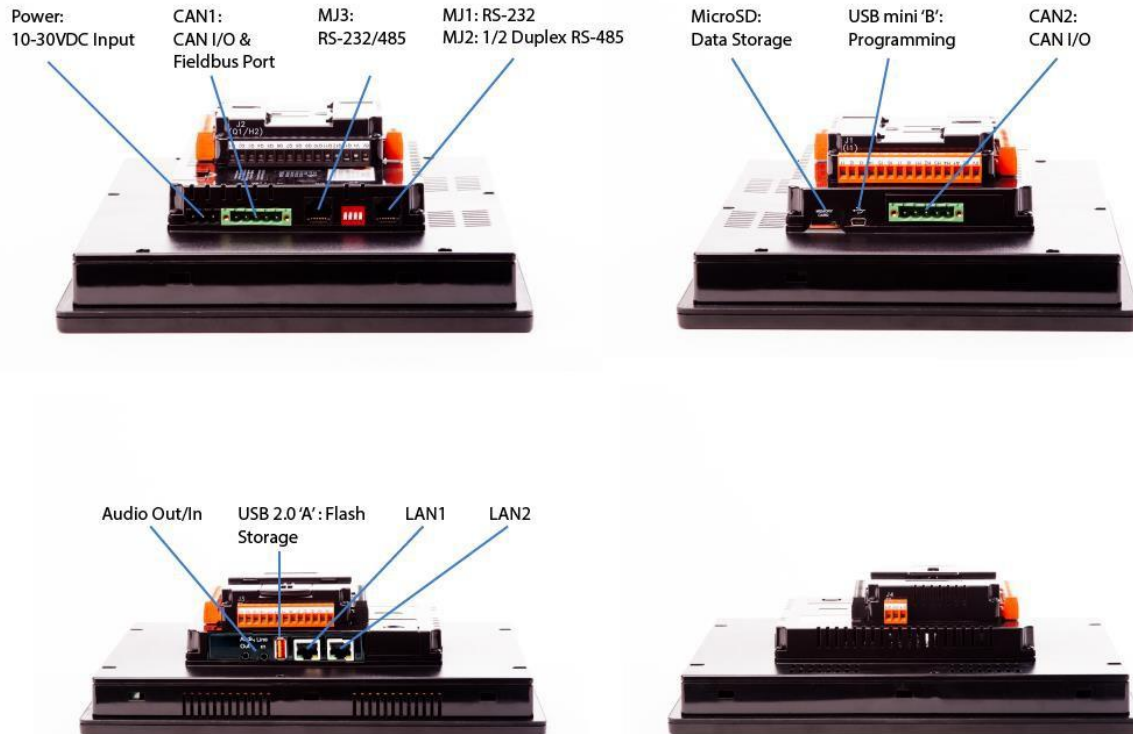

Figure 2.1 – Overview of the eXL10

2.1.1 Where to Find Information about the eXL10 OCS

- a) **Datasheet** - The **datasheet is the first document to refer to for key information** related to specific eXL10 OCS models.
 - a. The datasheets for all eXL10 OCS models are available on the Horner websites.
 - b. Datasheets contain pin-outs, jumper settings and other model specific information.
- b) **User Manual** -This manual provides general information that is common to eXL10 OCS models and can be downloaded from our web. Visit the Horner website (US: <http://www.heapg.com> or Europe: <http://www.horner-agg.com>) to obtain user documentation and updates.

2.1.2 Four main types of information are covered in this manual

- a) Safety and Installation guidelines / instructions (Mechanical and Electrical)
- b) Descriptions of hardware features
 - a. (Serial ports, Removable Media, Communication Options, etc.)
- c) Configuration and Use of the eXL10 OCS
- d) Maintenance and Support

2.1.3 Manual Index

Major topics of interest may be found in the [Index](#) towards the end of this manual.

2.1.4 Table of Figures

Location of important drawing, illustrations (etc.) may be found in the [Table of Figures](#).

2.2 Connectivity to the eXL10 OCS

The eXL10 OCS has excellent capabilities for connecting to a variety of devices. The diagram below shows some examples of devices that can be used with the eXL10 OCS.

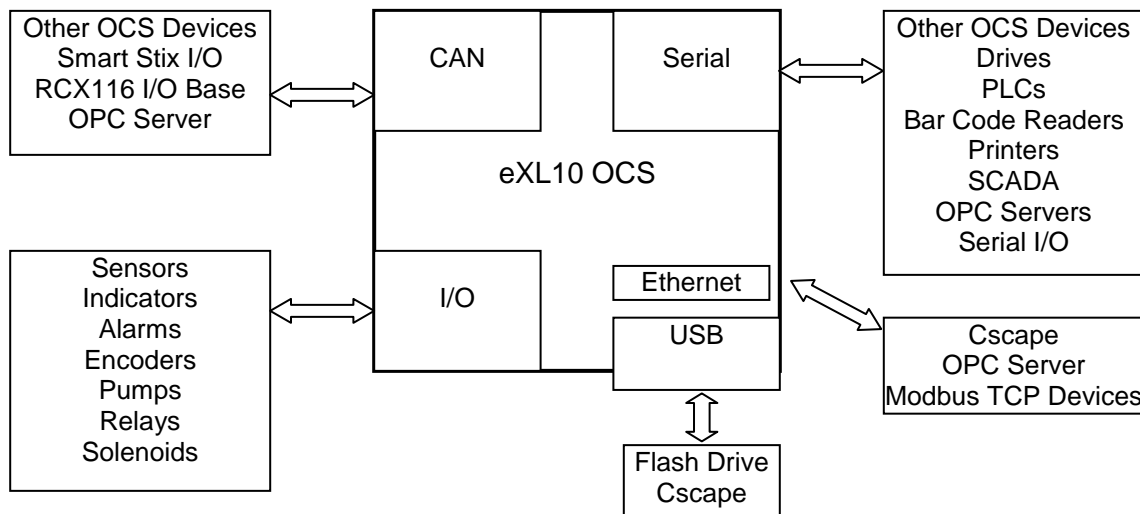

Figure 2.2 – Visual Overview of Types of Devices that can be connected to EXL10 OCS

2.3 Features of eXL10 OCS

The eXL10 OCS are all-in-one industrial control devices. They combine control, user interface, I/O and networking into a single, integrated package. Unique features of the eXL10 OCS include:

- Bright, 65,536 color graphical touch sensing LCD display in all models of eXL10.
- Display of complex graphical objects including trends, gauges, meters and animations.
- Very high performance graphic processing
- Advanced control capabilities including floating point, multiple auto-tuning PID loops and string handling capabilities.
- Removable media for 32GB of storage of programs, data logging or screen captures.
- CsCAN networking port for communication with remote I/O, other controllers or PCs.
- High speed USB port for communication with PCs and programming of controller.
- Configurable serial protocols for communication to drives, PLCs, or other serial peripherals.
- Full featured, built-in I/O including high resolution analog, thermocouple, RTD, high speed counters, PWM outputs and relays (depending upon the eXL10 OCS model used).
- Advanced high speed I/O capabilities
- Cscape programming software that allows all aspects of the eXL10 OCS to be programmed and configured from one integrated application.
- Optional communication add-on modules

- Two on board Ethernet ports (10/100Mbps) for Cscape programming and application defined communication, with Auto MDI/MDI-X.

2.4 Required and Suggested Accessories

The following list contains a *sampling* of required and suggested eXL10 OCS accessories. Visit the Horner websites to view updates on new products and accessories.

NOTE: The eXL10 OCS is not shipped with a programming cable in the box. To obtain a programming cable, order HE500CBL300.

Table 2.1 – eXL10 OCS Accessories	
Part Number	Description
HE-MC1	Removable Media card - compatible with eXL10 OCS. Card capacity is 2GB or larger.
HE-MR1	Media Card Reader for HE-MC1. Portable device allows HE-MC1 to be plugged into the USB port of personal computers as a portable hard drive.
HE-X24-AS	Power supply 100-240VAC or 140-340VDC Switching supply that outputs 1.5 A / 3 A (HE-X24-AS/AL) at 24 VDC. Mounts on Standard DIN rail. Designed for X Family products.
HE-X24-AL	Power supply 100-240 VAC or 140-340 VDC Switching supply that outputs 1.5 A / 3 A (HE-X24-AS/AL) at 24VDC. Mounts on Standard DIN rail. Designed for X Family products.
HECSP	Cscape Software Package on a reusable USB flash drive with symbol library.
HE-XCK	Programming cables for all X products including a USB to serial adapter in a travel case.
HE-CPK	Cscape on a reusable USB flash drive. Programming cables for all X products including a USB to serial adapter in a travel case.

2.5 Useful Documents and References

The following information serves as a *general* listing of Horner controller products and other references of interest with their corresponding manual numbers. Visit the Horner websites to obtain user documentation and updates.

Table 2.2 – OCS Reference Document numbers	
NOTE: This list is <u>not</u> intended for users to determine which products are appropriate for their application; controller products differ in the features that they support. If assistance is required, refer to Technical Support.	
Manual Description	Manual Number
User Manual for XLe/XLt OCS models	MAN0878
User Manual for XL6/XL6e OCS models	MAN0883
User Manual for XL4 OCS models	MAN0964
User Manual for QX Series models	MAN0798
User Manual for NX Series models	MAN0781
Other Useful References	Manual Number
Supplement for SmartStack Ethernet Modules	SUP0740
CAN Networks	MAN0799
Spark Quenchers for Arc and Noise Suppression (output protection)	MAN0962
Wiring Accessories and Spare Parts Manual	MAN0347

CHAPTER 3: MECHANICAL INSTALLATION

Note: The datasheet is the first document to refer to for model-specific information related to eXL10 OCS models such as pin-outs, jumper settings, and other key installation information. Visit the Horner websites to obtain datasheets, user documentation, and updates.

3.1 Overview

The mechanical installation greatly affects the operation, safety and appearance of the system. Information is provided to mechanically install the unit such as cut-out sizes, mounting procedures and other recommendations for the proper mechanical installation of the unit.

3.2 Mounting Requirements

3.2.1 Mounting Procedures (Installed in a Panel Door)

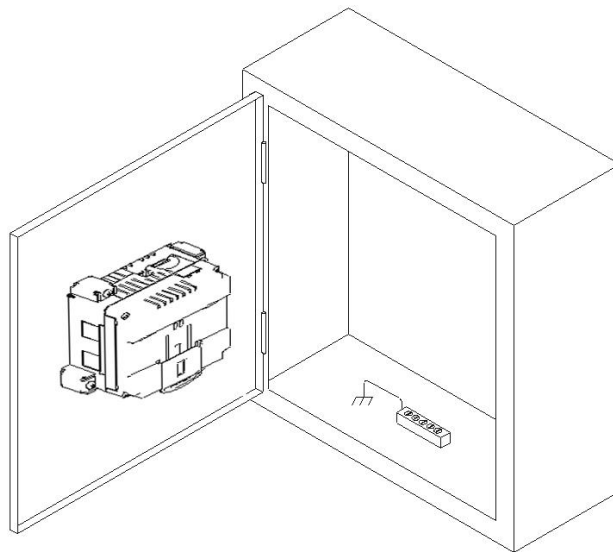

Figure 3.1 – Panel Mounting of an eXL10 Series OCS

Once the panel design has been completed using the criteria and suggestions in the following sections, use the following steps to panel mount the eXL10 OCS.

1. Remove all connectors from the eXL10 OCS unit.
2. Make sure the gasket is installed on the eXL10 OCS and is free from dust and debris. Check that the corners of the gasket are secure.
3. Pass the unit through the panel.
4. Insert each of the ten (**10**) mounting clips into the slots in the eXL10 OCS case. One clip should be installed on each corner. Lightly tighten each screw so the clip is held in place.
5. Tighten the screws on the clips such that the gasket is compressed against the panel. Recommended torque is 7-10 lb/in (0.8-1.13 Nm.)

3.3 Mounting Orientation

3.3.1 eXL10 OCS Mounting Clip



Figure 3.2 – eXL10 OCS with Mounting Clips

3.3.2 eXL10 OCS Mounting Orientation

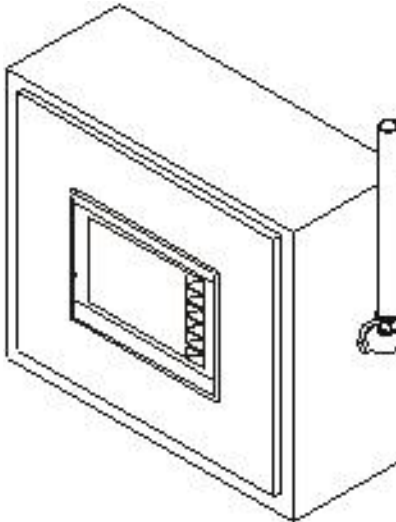

Figure 3.3 – Orientation of eXL10 OCS

NOTE: There are no orientation restrictions on the eXL10 OCS. However, the above orientation provides for optimum readability of the screen and ease of use of the keypad.

3.4 Panel Cut-Out

For installations requiring NEMA 4X liquid and dust protection the panel cutout should be cut with a tolerance of $\pm 0.005"$ (0.1 mm).

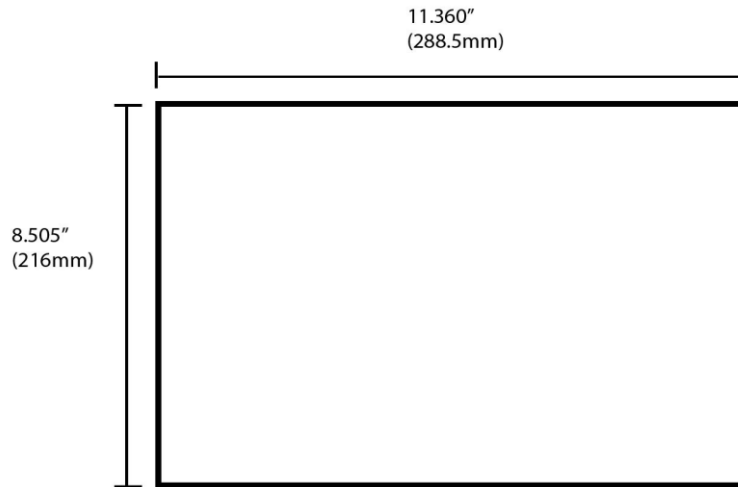

Figure 3.4 – Panel Cutout Tolerances

3.5 eXL10 Dimensions



Figure 3.5 – eXL10 OCS Dimensions

3.6 Factors Affecting Panel Layout Design and Clearances

Warning: It is important to follow the requirements of the panel manufacturer and to follow all applicable electrical codes and standards.

The designer of a panel layout needs to assess the requirements of a particular system and to consider the following design factors.

3.6.1 Clearance / Adequate Space

Install devices to allow sufficient clearance to open and close the panel door.

Table 3.1 – Minimum Clearance Requirements for Panel Box and Door	
Minimum Distance between base of device and sides of cabinet	2 inches (50.80mm)
Minimum Distance between base of device and wiring ducts	1.5 inches (38.10mm)
<u>If more than one device installed in panel box (or on door):</u> Minimum Distance between bases of each device	4 inches between bases of each device (101.60mm)
<u>When door is closed:</u> Minimum distance between device and closed door <i>(Be sure to allow enough depth for the OCS.)</i>	2 inches (50.80mm)

3.6.2 Grounding

Warning: Be sure to meet the ground requirements of the panel manufacturer and also meet applicable electrical codes and standards.

Panel box: The panel box must be properly connected to earth ground to provide a good common ground reference.

Panel door: Tie a low impedance ground strap between the panel box and the panel door to ensure that they have the same ground reference.

3.6.3 Temperature / Ventilation

Ensure that the panel layout design allows for adequate ventilation and maintains the specified ambient temperature range. Consider the impact on the design of the panel layout if operating at the extreme ends of the ambient temperature range. For example, if it is determined that a cooling device is required, allow adequate space and clearances for the device in the panel box or on the panel door.

3.6.4 Orientation

When panel-mounted, there are no orientation restrictions on the eXL10 OCS.

3.6.5 Noise

Consider the impact on the panel layout design and clearance requirements if noise suppression devices are needed. Be sure to maintain an adequate distance between the eXL10 OCS and noisy devices such as relays, motor starters, etc.

For details on output protection, especially when using contactors, solenoids... see MAN0962-01-EN.

3.6.6 Shock and Vibration

The eXL10 OCS has been designed to operate in typical industrial environments that may inflict some shock and vibration on the unit. For applications that may inflict excessive shock and vibration please use proper dampening techniques or relocate the eXL10 OCS to a location that minimizes shock and/or vibration.

3.6.7 Panel Layout Design and Clearance Checklist

The following list provides highlights of panel layout design factors:

- Meets the electrical code and applicable standards for proper grounding, etc.?
- Meets the panel manufacturer's requirements for grounding, etc.?
- Is the panel box properly connected to earth ground? Is the panel door properly grounded? Has the appropriate procedure been followed to properly ground the devices in the panel box and on the panel door?
- Are minimum clearance requirements met? Can the panel door be easily opened and closed? Is there adequate space between device bases as well as the sides of the panel and wiring ducts?
- Is the panel box deep enough to accommodate the eXL10 OCS?
- Is there adequate ventilation? Is the ambient temperature range maintained? Are cooling or heating devices required?
- Are noise suppression devices or isolation transformers required? Is there adequate distance between the base of the eXL10 OCS and noisy devices such as relays or motor starters? Ensure that power and signal wires are not routed in the same conduit.
- Are there other requirements that impact the particular system, which need to be considered?

NOTES

CHAPTER 4: ELECTRICAL INSTALLATION

Note: The datasheet is the first document to refer to for model-specific information related to eXL10 OCS models such as pin-outs, jumper settings, and other key installation information. Visit the Horner websites to obtain datasheets, user documentation, and updates.

4.1 Grounding Definition

Ground: The term *ground* is defined as a conductive connection between a circuit or piece of equipment and the earth. Grounds are fundamentally used to protect an application from harmful interference causing either physical damage such as by lightning or voltage transients or from circuit disruption often caused by radio frequency interference (RFI). Grounding is also for the safety of the user.

4.2 Ground Specifications

Ideally, a ground resistance measurement from equipment to earth ground is 0 ohms. In reality it typically is higher. The U.S. National Electrical Code (NEC) states the resistance to ground shall not exceed twenty-five (25) ohms. Horner APG recommends *less than* fifteen (15) ohms resistance from our equipment to ground. Resistance *greater than* twenty-five (25) ohms can cause undesirable or harmful interference to the device.

4.3 How to Test for Good Ground

In order to test ground resistance, a Ground Resistance Tester must be used. A typical Ground Resistance Meter Kit contains a meter, two or three wire leads, and two ground rods. Instructions are supplied for either a two-point or three-point ground test.

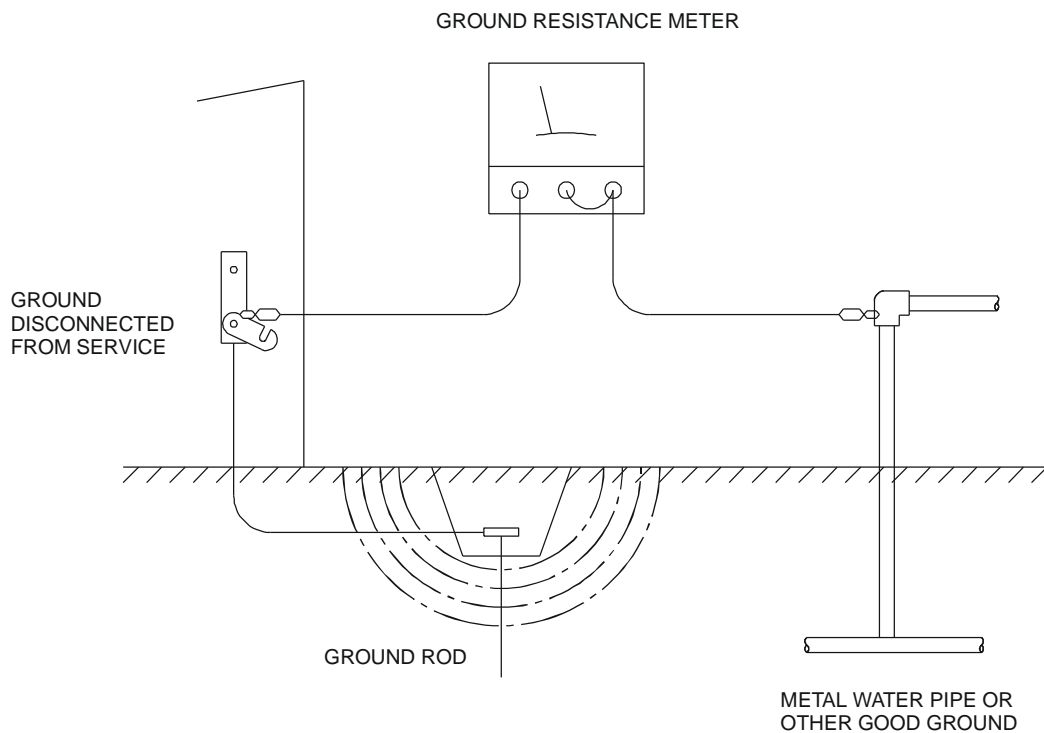

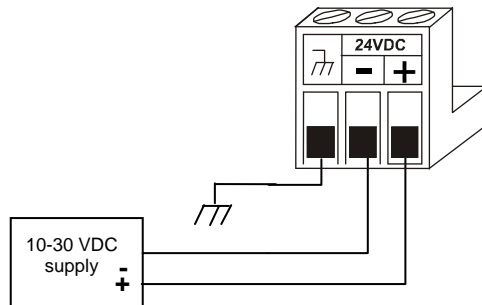

Figure 4.1 – Two-Point Ground Connection Test

4.4 Primary Power Port

Table 4.1 – Primary Power Port Pins		
PIN	Signal	Description
1		Frame Ground
2	0V	Input power supply ground
3	+24V	Input power supply positive voltage



Power Connector

Power Up:

Connect to Earth Ground.
Apply 10 – 30 VDC.
Screen lights up.
Torque rating 4.5 - 7 Lb-In
(0.50 – 0.78 N-m)

Figure 4.2 – Power Connector (Primary Power Port)

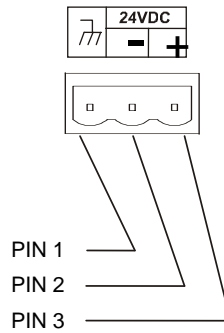

Figure 4.3 – Primary Power Port as Viewed Looking at the eXL10 OCS

CHAPTER 5: SERIAL COMMUNICATIONS

5.1 Overview

All eXL10 OCS models provide two independent serial ports, on the first 8-pin modular RJ45 connector, which is labeled **MJ1/MJ2**. The MJ1 serial port is RS232 while the MJ2 port is RS485. By default, MJ1 can be connected to the COM port of a PC running Cscope, for OCS programming. In addition, both MJ1 and MJ2 can be used for application-specific communication, using a variety of standard data exchange protocols.

The second 8-pin modular RJ45 connector, which is labeled **MJ3**, provides a multiplexed serial port, which can be configured for either RS232 or RS485. MJ3 can be optionally set for OCS programming via the System Menu for connection to the COM port of a PC running Cscope.

5.2 Port Descriptions

The MJ1 serial port contains an RS232 interface with RTS/CTS handshaking. The MJ2 serial port contains a half-duplex RS485 interface with no handshaking. The MJ3 serial port can be configured as either RS232 or RS485. The MJ2 and MJ3 RS485 interfaces provide switchable termination and bias resistors internally, which can be enabled/disabled with DIP switches.

5.3 Wiring and Dip Switches

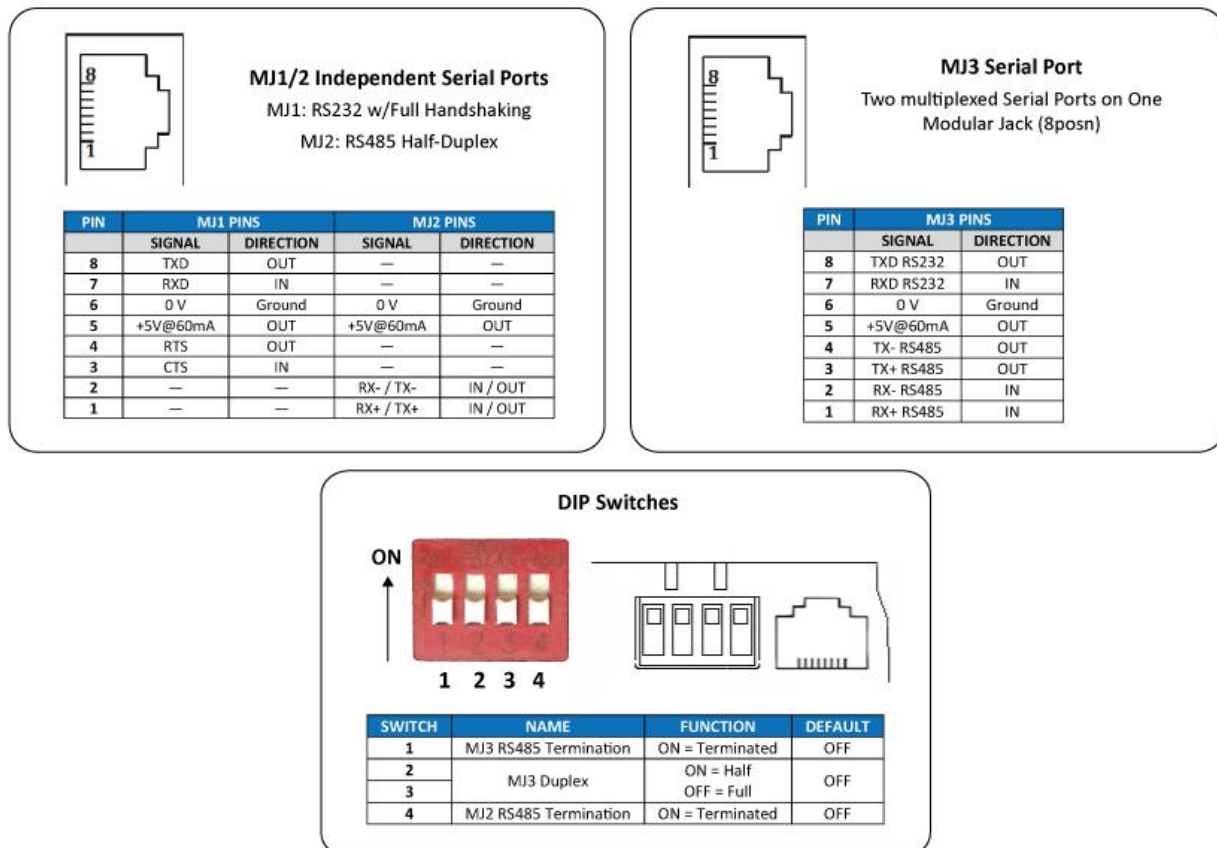

Figure 5.1 – Wiring & Dip Switches

5.4 RS485 Termination

Proper RS485 termination minimizes signal reflections and improves reliability.

Both the MJ2 and MJ3 serial ports allow an internal termination resistor to be placed across pins 1 and 2 by DIP Switch Setting.

Only the two devices physically located at the endpoints of the RS485 network should be terminated.

5.5 RS485 Biasing

RS485 biasing passively asserts a line-idle state when no device is actively transmitting, which is useful for multi-drop RS485 networking.

Both the MJ2 and MJ3 serial ports allow internal bias resistors to be switched in, pulling pin 1 up to 3.3V and pulling pin 2 down to ground. The Set Serial Ports item in the System Menu can be used to enable RS485 biasing. Also, an application graphics screen that writes to %SR164 can do the same thing. Setting %SR164.1 enables MJ2 biasing and setting %SR164.2 enables MJ3 biasing.

If biasing is used, it should be enabled in only one of the devices attached to the RS485 network.

5.6 Cscape Programming via Serial Port

The eX0L10 OCS MJ1 and MJ3 serial ports support CsCAN Programming Protocol. If a PC COM port is connected to the EXL10 OCS MJ1 or MJ3 serial port, Cscape can access the eXL10 OCS for programming and monitoring. Programming can also be done via the CAN port, USB A port or Ethernet.

5.7 Ladder-Controlled Serial Communication

Using Serial Communication function blocks, MJ1, MJ2 and MJ3 serial ports support Generic Modbus Master and Modbus Slave Protocols. In addition, external modems can be connected and accessed using Init, Dial and Answer Modem function blocks.

5.8 Downloadable Serial Communication Protocols

MJ1, MJ2 and MJ3 also support downloadable protocols, such as Allen Bradley DF1, CsCAN Master, GE Fanuc SNP and Modbus Master.

NOTE: Refer to the download section of the Horner websites for the list of latest supported protocols.

CHAPTER 6: CAN COMMUNICATIONS

Note: For additional CAN information, refer to the CAN Networks manual (MAN0799) on the Horner websites.

6.1 Overview

All eXL10 OCS models provide two CAN network ports, which are implemented with 5-pin connectors. The connectors are labeled **CAN1** and **CAN2**.

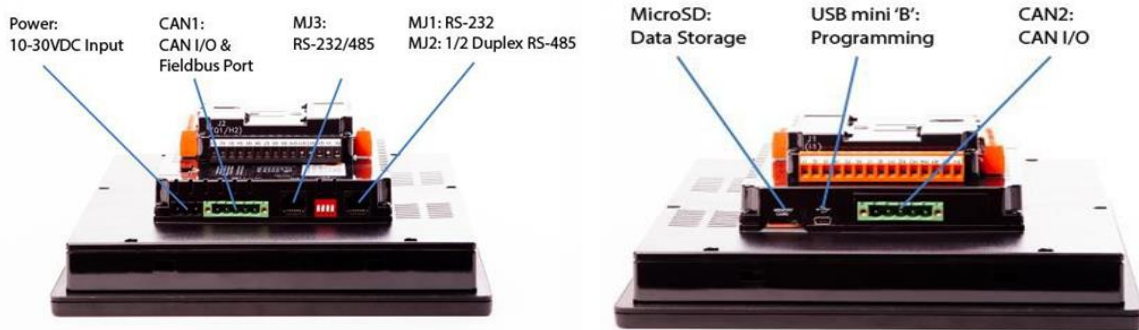

Figure 6.1 – CAN1 & CAN2 Connector Locations

Like the MJ1 serial port, the CAN1 port can be used for eXL10 OCS programming by connecting it to the CAN port of a PC running Cscope. The CAN1 port also allows the eXL10 OCS to exchange global data with other OCS/RCS controllers. Both CAN1 and CAN2 support accessing of remote network I/O devices (SmartStix, SmartBlock and SmartRail Modules.)

CAN2 port supports CsCAN, CANopen, J1939 and DeviceNet Master (layer 3 as a selectable option – one only)

6.2 Port Description

The eXL10 OCS CAN ports implement the ISO 11898-2 physical layer and the CAN 2.0A data link layer standards. Also, since the CAN ports are powered by an internal isolated power supply, external CAN power is not required.

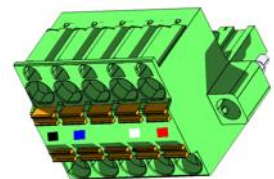

6.3 CAN Port Wiring

CAN Connector

Use the CAN Connector when using CsCAN or other CAN network.

Torque rating 4.5 – 7 Lb-In
(0.50 – 0.78 N-m)

CAN1 & CAN2 Port Pins			
Pin	Signal	Signal Description	Direction
1	V-	Power -	–
2	CN_L	CAN Data Low - Blue	In/Out
3	SHLD	Shield	–
4	CN_H	CAN Data High - White	In/Out
5	V+	Power +	–

Figure 6.2 – CAN1 / CAN2 Port Pins

6.4 Cscape Programming via CAN

The CAN1 port supports CsCAN Programming Protocol. If a PC has a CAN interface installed (via PCI card or USB), and the PC CAN port is connected to the eXL10 OCS CAN1 port, Cscape can access the eXL10 OCS for programming and monitoring.

In addition, the eXL10 OCS supports single-point-programming of all eXL10 OCS and other OCS/RCS devices that are connected to the CAN1 port network. If the PC COM port is connected to the eXL10 OCS MJ1 serial port, the eXL10 OCS can act as a pass-through gateway allowing Cscape to access all eXL10 OCS and OCS/RCS devices that are attached to the CAN1 port network.

6.5 Ladder-Controlled CAN Communication

Using Put and Get Network Words function blocks, the CAN 1 port can exchange digital and analog global data with other eXL10 OCS or OCS/RCS devices (nodes) attached to the CAN1 port network.

In addition, Put and Get Network Heartbeat function blocks allow nodes on the CAN 1 port network to regularly announce their presence and to detect the presence (or absence) of other nodes on the network.

6.6 Using CAN for I/O Expansion (Network I/O)

Connecting Network I/O devices (SmartStix, SmartBlock or SmartRail) to the eXL10 OCS CAN1 or CAN2 port, allows the eXL10 OCS I/O to be economically expanded and distributed. A variety of modules are available for this purpose.

CHAPTER 7: ETHERNET COMMUNICATION

7.1 Ethernet Module Protocols and Features

The following table describes the Ethernet Module Protocols and features supported by the two Ethernet ports on the eXL10.

Protocol / Feature	Protocol / Feature Description
ICMP Ping	Internet Control Message Protocol
EGD (Peer)	Ethernet Global Data
SRTP Server	Service Request Transfer Protocol
CsCAN TCP Server	Horner APG CsCAN over Ethernet
Modbus TCP Slave	Modbus over Ethernet
Ethernet / IP Server	ODVA CIP over Ethernet
FTP Server	File Transfer Protocol
HTTP Server	HyperText Transfer Protocol (Web Server)

Table 7.1 – Ethernet Module Protocols & Features

7.2 Ethernet System Requirements

Full Ethernet functionality requires:

- PC running Cscape Programming Software Version 9.3 SP6 or later (for configuration).
- eXL10 controller with onboard Ethernet port.
- FTP & HTTP protocols.

7.3 Ethernet Module Specifications

Speeds	10 BaseT Ethernet (10-Mbps) 100 BaseTx Fast Ethernet (100-Mbps)
Modes	Half or Full Duplex
Auto-Negotiation	Both 10/100-Mbps and Half/Full Duplex
Connector Type	Shielded RJ-45
Cable Type (Recommended)	CAT5 (or better) UTP
Port	Auto MDI/MDI-X (Auto Crossover)

Table 7.2 – Ethernet Module Specifications

7.4 Ethernet Module Configuration

Note: The following configuration is required for all applications regardless of the protocols used. Additional configuration procedures must be performed for each protocol used.

To configure the Ethernet Module, use Cscape Programming Software to perform the following steps

1. On the main Cscape screen, select the **Controller** menu and its **I/O Configure** sub-menu to open the I/O Configuration dialog (Figure 7.1)
2. If configuring a different OCS Model than the one shown in the I/O Configuration dialog, click on the topmost **Config** button, select the desired OCS Model, and then click **OK**

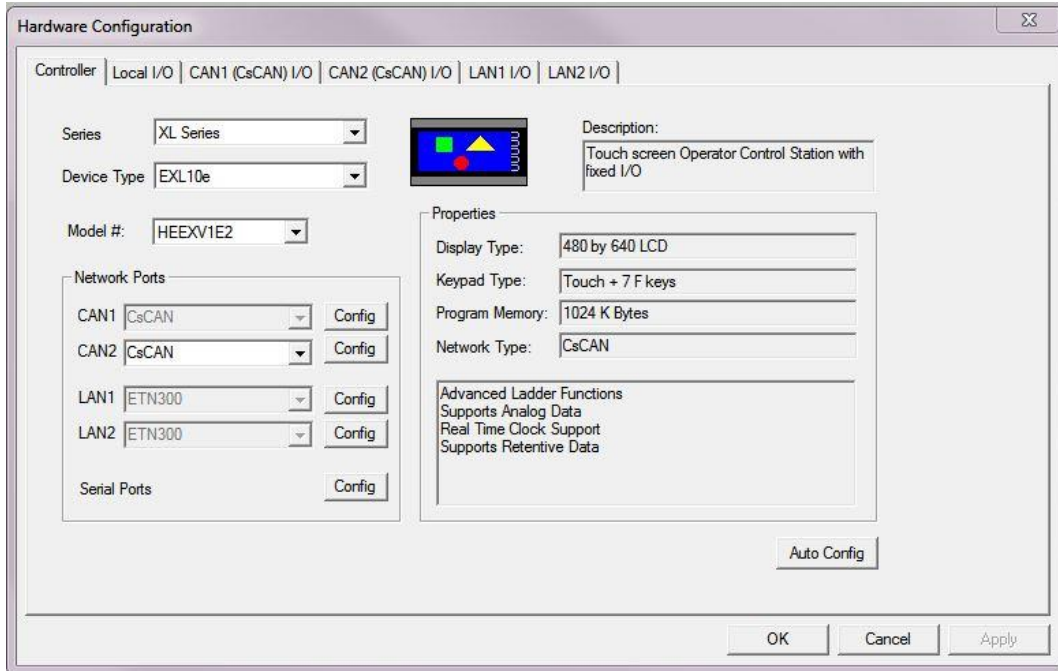

Figure 7.1 – I/O Configuration Dialog

3. Click the **Config** button to the right of LAN1 for LAN 1 or LAN2 for LAN2, revealing the Ethernet Module Configuration dialog as shown in figure 7.2

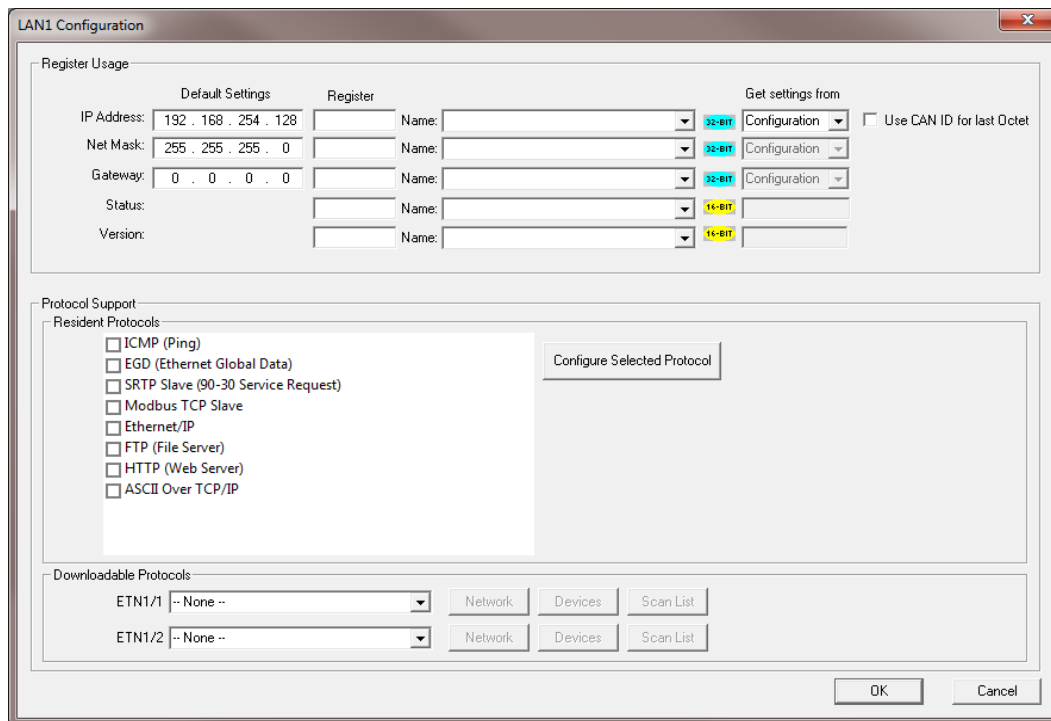

Figure 7.2 – Ethernet Module Configuration

4. Configure the Ethernet Module parameters as follows:

IP Address: Enter the static IP Address for the Ethernet Module being configured.

Note: IP Addresses are entered as four numbers, each ranging from 0 to 255. These four numbers are called octets and they are always separated by decimal points.

Net Mask: Enter the Net Mask (sometimes called Subnet Mask) being used by all nodes on the local network. Typical local networks use Class C IP Addresses, in which case the low octet (rightmost number) is used to uniquely identify each node on the local network. In this case, the default Net Mask value of 255.255.255.0 should be used.

Gateway: Enter the IP Address of a Gateway Server on the local network that allows for communication outside of the local network. To prevent the Ethernet Module from communicating outside the local network, set the Default Gateway IP Address to 0.0.0.0 (the default setting).

Status Register: Enter an OCS Register reference (such as %R100) to indicate which 16-bit OCS register will have the Ethernet Status word written to it. Table 7.3 shows how this register value is formatted and explains the meaning of each bit in the Status Word.

Table 7.3 - Ethernet Status Word Register Format															
High Byte								Low Byte							
Bit 16	Bit 15	Bit 14	Bit 13	Bit 12	Bit 11	Bit 10	Bit 9	Bit 8	Bit 7	Bit 6	Bit 5	Bit 4	Bit 3	Bit 2	Bit 1
0	0	Dup	Spd	0	Rx	Tx	Link	TCP Connections							
Status Bit(s)		Status Indication						Status Values							
0		Reserved						Always 0							
Dup		Link Duplex (Auto-Negotiated)						0 = Half Duplex 1 = Full Duplex							
Spd		Link Speed (Auto-Negotiated)						0 = 10 MHz 1 = 100 MHz							
Rx		Receive State						0 = Inactive 1 = Active							
Tx		Transmit State						0 = Inactive 1 = Active							
Link		Link State						0 = Down 1 = Up							
TCP Connections		Total Number of Active TCP Connections (CsCAN, SRTP, Modbus, EIP, FTP, HTTP)						0 40							

Version Register: Enter an OCS Register reference (such as %R101) to indicate which 16-bit OCS register will have the Ethernet Firmware Version written to it. The value stored in the Version Register is: (Ethernet Firmware Version * 100). For example, for Ethernet Firmware Version 4.30, the Version register will contain 430.

Get Settings From:

“Get settings from” allows the programmer to either configure the IP Address, Net Mask, or Gateway for 2 functions: Configuration or Register

Configuration – The configuration for the IP Address, Net Mask, or the Gateway will be assigned using the value in the Default Settings in this window.

Register – The configuration for the IP Address, Net Mask, or the Gateway will be assigned using the values in the registers assigned.

Ethernet Module Protocol Configuration

The Protocol Support area contains a list of all the protocols supported by the platform being configured. To activate a protocol, check its checkbox.

For protocols that require additional configuration, click on a listed protocol to select it and then click the Configure Selected Protocol button. This will open a new dialog with configuration options for the selected protocol.

For detailed information on individual protocol configuration refer latest version of ETN 300 Manual **SUP0740**

NOTES

CHAPTER 8: COMMUNICATION OPTIONS

8.1 Overview

To supplement the built-in MJ1, MJ2 and MJ3 serial ports, additional communication options are available. This is accomplished by installing a COM module in the eXL10 OCS controller.

Previous OCS controllers shared a serial port with the communication options. The eXL10 has a separate serial port which allows using MJ1, MJ2, MJ3 and the communication options simultaneously. Internal to the eXL10 OCS, there is a CPU board, and up to two installed modules. Models **HE-EXV1E0 / HEXT505C100** have no installed I/O or add-on COM modules (standard communications are available). All other models have an I/O module in Slot 1 and could have a user-installed COM module in Slot 2. A blank I/O board kit to support a COM module in these models is available.

This chapter briefly describes the Modem COM module options. For detailed information regarding these modules, please refer to the individual documents provided with the modules.

8.2 Modem COM Module (XMC) Option

A Modem COM module can be installed to allow Cscape programming of an eXL10 OCS over a dial-up network. In addition, the application ladder program can take control of the modem for application-specific modem communication.

The Modem COM module supports the standard AT command set and can connect to the dial-up network at speeds up to 14.4 Kbaud. Connection speed is auto-negotiated. The Modem COM module connects to the dial-up network (phone line) via a cable with a standard RJ11 modular plug.

To enable Cscape programming via a dial-up network, the Modem COM module should first be configured as the Default Programming Port, using the eXL10 OCS System Menu. Doing this puts the Modem COM module in auto-answer mode, so Cscape can call the eXL10 OCS via a remote modem.

To program the ladder application to communicate via the Modem COM module, standard Cscape Serial and Modem function blocks can be used.

Additional XL Series COM options are shown below:

Part Number	Description
HE-XDAC007	2-channel Analog Out (mA/V)
HE-XDAC107	4-channel Analog Out (mA/V)
HE-HXSQ	24V Dual High Speed Output
HE-XHSQ-5	5V Dual High Speed Output
HE-XEC	Add-on Ethernet
HE-XPBS	Profibus DP Slave
HE-XRC9	900 MHz I W Radio Modem
HE-GSM04*	GSM/GPRS Cellular Modem
HE-200GPS183**	GPS Receiver

*add ANT suffix to include antenna, **external unit

Table 8.1 – XL Series COM Options

CHAPTER 9: REMOVABLE MEDIA

9.1 Overview

All eXL10 OCS models provide a Removable Media slot, labeled **Memory Card**, which supports standard MicroSD Flash memory cards. MicroSD cards can be used to save and load applications, to capture graphics screens and to log data for later retrieval.

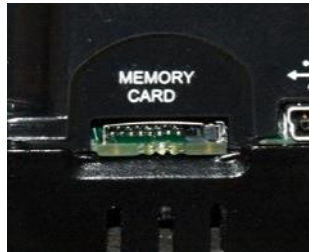

Figure 9.1 – Removable MicroSD Memory Card Slot

9.2 MicroSD Cards

When the MicroSD card format was introduced, it was originally called TransFlash. Cards labeled either MicroSD or TransFlash, with up to 32 GB of Flash memory, are compatible with the eXL10 OCS Memory slot (larger sizes were not tested at time of publication).

The Memory slot is equipped with a “push-in, push-out” connector and a MicroSD card can be safely inserted into the Memory slot whether the eXL10 OCS power is On or Off.

To install a MicroSD card: Align its 8-pin gold edge connector down, facing the front of the eXL10 OCS unit as shown in **Figure 9.2**; then carefully push it all the way into the Memory slot. Ensure that it clicks into place.

To remove the MicroSD card: Push in on the top of the card gently to release the spring. The card pops out for removal.

9.3 MicroSD File System

The MicroSD Memory slot uses the PC-compatible FAT32 File System. This means that a PC, with a MicroSD-compatible card reader, can read files that have been written by the eXL10 OCS and can write files that can be read by the eXL10 OCS.

However, the eXL10 OCS does not support long filenames, but instead implements the 8.3 filename format. This means that all file and directory names must consist of up to 8 characters, followed by an optional dot, and an optional extension with up to 3 characters.

Directories and sub-directories can be nested up to 16 levels deep as long as each pathname string does not exceed 147 characters.

9.4 Using the Removable Media Manager

The Removable Media Manager is an interactive eXL10 OCS screen that performs the following functions:

- a. Display number of total and free K bytes
- b. Browse file and directory lists
- c. Delete files and directories
- d. Format a MicroSD card
- e. Load and save application programs
- f. View screen capture bitmaps

The Removable Media Manager can be accessed via the System Menu or by using Cscape to place a Removable Media Manager object on an application graphics screen.

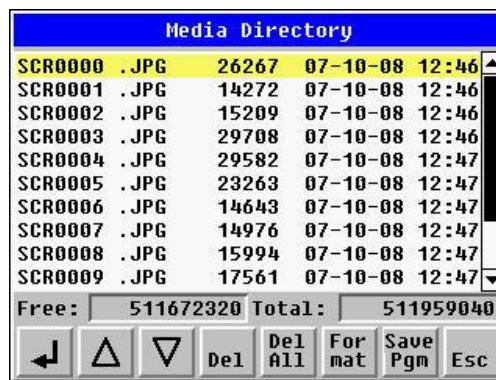



Figure 9.2 – Removable Media Submenu

9.5 Using Removable Media to Log Data

Using Read and Write Removable Media function blocks, an application ladder program can read and write eXL10 OCS register data in the form of comma-delimited files, with a .CSV extension. These files are compatible with standard database and spreadsheet PC programs. In addition, an application ladder program can use Rename and Delete Removable Media function blocks to rename and delete files.

9.6 Using Removable Media to Load and Save Applications

A special file type, with a .PGM extension, is used to store eXL10 OCS application programs on MicroSD.

To load an application from MicroSD to the eXL10 OCS, use the Removable Media Manager (open the Removable Media Manager in the System Menu) to find and highlight the desired .PGM file, and then press the Enter key. 

To save an application from the eXL10 to MicroSD, open the Removable Media Manager in the System Menu and press the Save Pgm  function key. The application will be saved in a file called **DEFAULT.PGM** in the MicroSD root directory.

NOTE: Saving an application to MicroSD can only be done from the Removable Media System Menu and is not available on a Removable Media Manager object that was placed on an application graphics screen by Cscape.

Cscape can also save an application directly to a MicroSD card, which is plugged into the PC's MicroSD compatible card reader by selecting the Export to Removable Media item on the Cscape File menu.

9.7 Using Removable Media to View and Capture Screens

The eXL10 OCS File System uses bitmap files with the .BMP extension or JPEG files with the .JPG extension to store eXL10 OCS graphic screen captures.

To view a captured eXL10 OCS screen, use the Removable Media Manager to find and highlight the desired .BMP or .JPG file, and then press Enter. 

To capture an eXL10 OCS screen, turning On the assigned **Screen Capture Control Register** will capture the current eXL10 OCS graphics screen and write it to the MicroSD card using the assigned **Screen Capture Filename**.

Before capturing an eXL10 OCS screen, Cscape must first be used to assign a **Screen Capture Control Register** and **Filename** in the application. To do this, first open the Graphics Editor by selecting the **View / Edit Screens** item on the Cscape **Screens** menu. Next select the **Screen Capture** item of the Graphics Editor Config menu and then enter a **Control Register** and **Filename**.

9.8 Removable Media (RM) Function Blocks in Cscape

NOTE: For detailed information regarding RM function blocks and parameters, refer to the help file in Cscape Software. Refer 'USB Flash Media support for RM Functions' for USB flash drive access details.

The following RM functional blocks are available in Cscape Software. These function blocks will reference

- MicroSD when filename is prefixed with 'A:' or nothing OR
- USB A Flash Drive when filename is prefixed with 'B:'.

Read RM csv	Allows reading of a comma-separated value file from the MicroSD interface into the controller register space.
Write RM csv	Allows writing of a comma-separated value file to the MicroSD interface from the controller register space.
Rename RM csv	Allows renaming a file on the RM card. The data in the file is not changed.
Delete RM csv	Allows deleting a file on the RM card
Copy RM csv	Allows copying a file on the RM card. The data in the file is not changed.

9.9 Filenames used with the Removable Media (RM) Function Blocks

The RM function blocks support the flash with a DOS/Windows standard FAT-16 file system. All names must be limited to the "8.3" format where the filename contains eight characters a period then a three-character extension. The entire filename including any path must be less than or equal to 147 characters.

When creating filenames and directories it is sometimes desirable to include parts of the current date or time. There are six special symbols that can be entered into a filename that are replaced by the OCS with current time and date information.

Table 9.1 – Filename Special Symbols		
Symbol	Description	Example
\$Y	Substitutes the current 2 digit year	2004 = 04
\$M	Substitutes the current month with a 2 digit code	March = 03
\$D	Substitutes the current day	22 nd = 22
\$h	Substitutes the current hour in 24 hour format	4 pm = 16
\$m	Substitutes the current minute	45 = 45
\$s	Substitutes the current second	34 = 34

Note that all the symbols start with the dollar sign (\$) character. Date symbols are in upper case, time symbols are in lower case. The following are examples of the substituted time/date filenames:

Current date and time	= March 1, 2013 3:45:34 PM
Filename: Data\$M\$D.csv	= Data0301.csv
Filename: Year\$Y\Month\$M\aa\$D_\$h.csv	= Year04\Month03\aa01_15.csv
Filename: Month_\$M\Day_\$D\h_\$m_\$s.csv	= Month_03\Day_01\15_45_34.csv

9.10 System Registers used with RM

%SR175 Status	This shows the current status of the RM interface
%SR176 Free Space	This 32-bit register shows the free space on the RM card in bytes
%SR178 Card Capacity	This 32-bit register shows the total card capacity in kilobytes

Possible status values are shown in the table:

Table 9.2 – RM Status Values	
0	RM interface OK
1	Card present but unknown format
2	No card in slot
3	Card present, but not supported
4	Card swapped before operation was complete
5	Unknown error

For additional status information, consult the Cscape help file.

CHAPTER 10: GENERAL I/O

Note: Each eXL10 OCS unit is sent with a datasheet in the box. The datasheet is the first document to refer to **for model-specific information related to eXL10 OCS models such as pin-outs, jumper settings, and other key installation information.** Visit the Horner websites to obtain datasheets, user documentation, and updates.

10.1 Overview

The eXL10 OCS is a compact unit that contains high density, very versatile I/O. Using the I/O properly requires wiring to the proper terminals, configuring jumpers inside the eXL10 OCS unit and configuring Cscape properly. This section will offer some tips and suggestions to configure the I/O properly. For the register mapping of the I/O, refer to the [Index](#) at the end of this manual for the pages referencing register mapping.

10.2 Removing the eXL10 OCS I/O Cover

WARNING: Power, including I/O power *must be removed* from the unit prior to removing the back cover. Failure to do so could result in electrocution and/or damage to equipment

Some I/O configurations require jumper settings to be changed in the eXL10 OCS unit. Examples of these settings are setting positive or negative logic on digital inputs or setting current or voltage on analog inputs.

Each eXL10 OCS I/O jumper is set to a factory default. Refer to the eXL10 datasheet to find the default setting to determine if a jumper change is necessary for a particular application.

To remove the I/O cover of the eXL10 OCS, remove the four (4) Phillips screws from the I/O back. It may help to place the eXL10 OCS unit face down on a clean work surface. Once the four screws are removed the I/O cover can be lifted straight off.

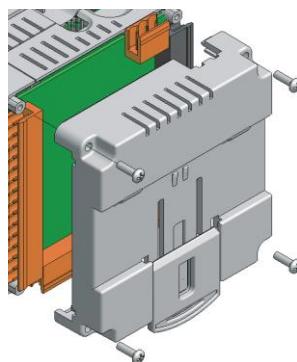

Figure 10.1 – Removing the I/O Cover

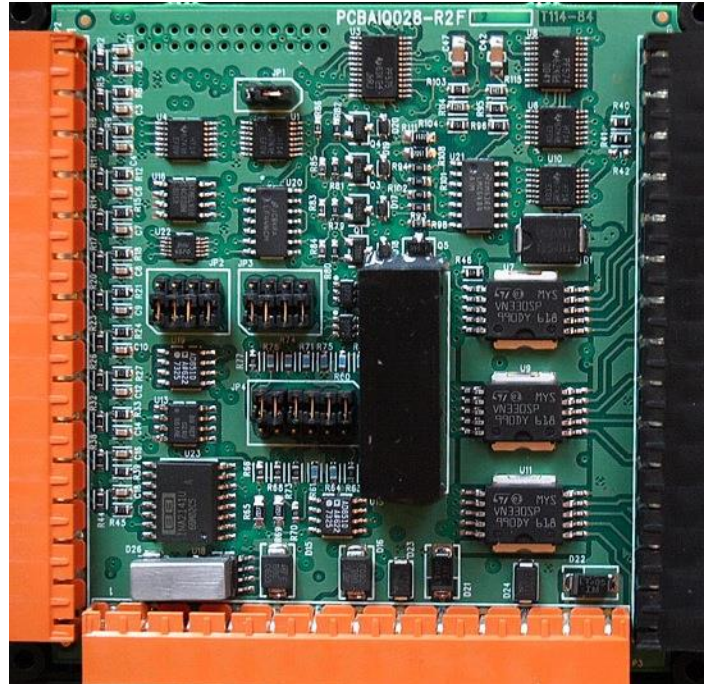

Figure 10.2 – eXL10 I/O Cover Removed (sample I/O board)

Once the back is removed the jumper selection can be changed. The jumper settings are documented on each data sheet using a diagram such as Figure 9.4 below and a description of the jumper settings.

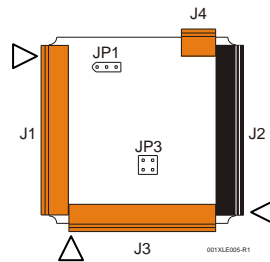

Figure 10.3 – Example Jumper Diagram

To re-install the cover, place the I/O cover back on the unit.

Place the screw back into the hole and turn the screw slowly counter clockwise until it clicks into the threads. This prevents the screw from being cross-threaded. Now turn the screw clock-wise until the cover is firmly secured. Repeat this process for all four (4) screws.

Ensure not to exceed the recommended max torque of 7-10 lb-in. [0.8 – 1.13 Nm.]

10.3 Model and I/O Overview

Table 10.1 – I/O and Model Overview								
EXL10 Models	DC In	DC Out	Relays	HS In	HS Out	mA/V In	mA/V RTD/Tc	mA/V Out
HE-EXV1E0 / HEXT505C100								
HE-EXV1E2 / HEXT505C112	12		6	4		4		
HE-EXV1E3 / HEXT505C113	12	12		4	2	2		
HE-EXV1E4 / HEXT505C114	24	16		4	2	2		
HE-EXV1E5 / HEXT505C115	12	12		4	2		2	2
HE- EXV1E6 / HEXT505C116	12	12		4	2	6*	6*	4*

Table 10.1 shows the different types of I/O included with the various eXL10 OCS models. Specific specifications, jumper settings and wiring diagrams can be found on the data sheets attached at the end of the manual. Descriptions and applications of the different type of I/O can be found below.

*up to six mA/V In, mA/V RTD/Tc, and 4 mA/V Out.

10.4 Solid-State Digital Outputs

Solid-state digital outputs are generally used to activate lamps, low voltage solenoids, relays and other low voltage and low current devices.

NOTE: The digital outputs used on the eXL10 OCS are “sourcing” outputs. This means the output applies a positive voltage to the output pin when turned ON. When turned off, the output applies approximately zero volts with respect to the I/O ground.

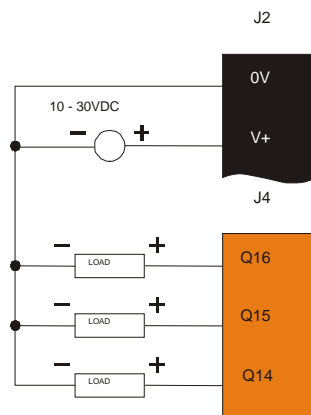

Figure 10.4 – Typical Output Wiring

The digital outputs used in the eXL10 OCS have electronic short circuit protection and current limiting. While these electronic protections work in most applications, some application may require external fusing on these outputs.

The digital outputs in the eXL10 OCS are typically controlled via %Q bits in the register mapping. Some of the outputs are designed for high-speed applications and can be used for PWM or frequency output applications. Please see the data sheet and the chapter on High Speed I/O for additional information.

When the controller is stopped the operation of each output is configurable. The outputs can hold the state they were in before the controller stopped or they can go to a predetermined state. By default digital outputs turn off. For more information on stop state see the [Index](#) to find pages referencing Cscape settings.

The digital outputs feature an output fault bit. %I32 will turn on if any of the outputs experience a short circuit, over-current or the output driver overheats.

10.5 Relay Outputs

Relay outputs are designed to switch loads that typically have high voltage or current requirements or require the isolation that relays provide.

NOTE: *The design of the eXL10 OCS does not require external coil power for the relays to function. The relays will activate anytime the eXL10 OCS is powered.*

There are several factors that should be considered when using relays:

Relay Life – Relays are mechanical devices that have a long but limited life. Typically, switching more current limits the life of relays. Please check the data sheets at the end of this manual for expected relay life.

Current / Temperature De-Rating – Products containing relays often have total current limits based on the ambient temperature of the application. Please see the product data sheet for current / temperature de-rating information for relays.

Fusing – External fusing is generally required to protect the relays, devices and wiring from shorts or overloads.

Warning: To protect the module and associated wiring from load faults, use external (5 A) fuse(s) as shown. Fuses of lower current or fusing for the entire system need to be in place to assure the maximum current rating of the unit is not exceeded.

Warning: Connecting high voltage to any I/O pin can cause high voltage to appear at other I/O pins.

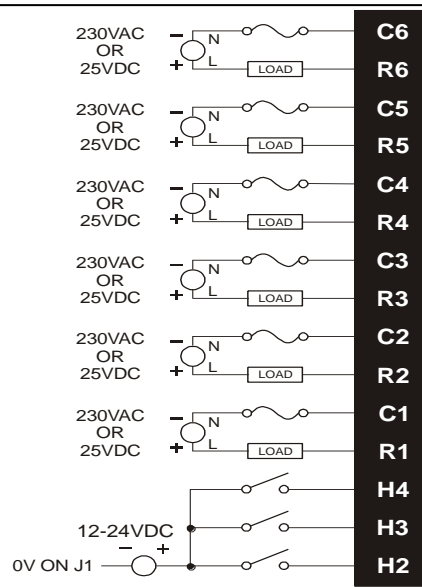

Figure 10.5 – Relay Fusing

Protection for Inductive Loads

Inductive loads can cause reverse currents when they shut off that can shorten the life of relay contacts. Some protective measures need to be determined by an engineer. If you have questions on protection from inductive load, consult an application engineer or HEAPG Technical Support. Details on devices that may protect outputs can be found in MAN0962-01.

Output State on Controller Stop

When the controller is stopped the operation of each output is configurable. The outputs can hold the state they were in before the controller stopped or they can go to a predetermined state. By default relay outputs turn off. For more information on stop state see the [Index](#) for Cscape settings pages.

10.6 Digital Inputs

NOTE: Refer to the datasheet for eXL10 OCS model being used for details on jumper settings.

Note: The digital inputs on the eXL10 OCS are designed for low voltage DC inputs. The inputs are designed to support both positive and negative input modes. The mode is set by a jumper setting and a configuration parameter in Cscape. All the inputs on the unit must be configured to the same mode.

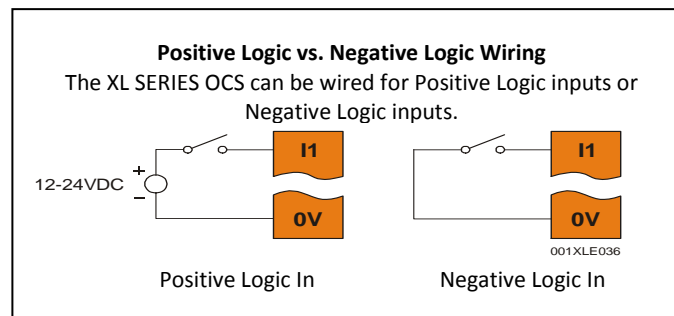

Figure 10.6 – Positive and Negative Inputs

In positive logic mode a positive voltage applied to the input will turn the input. The internal design of this mode is basically a resistor from the input to I/O ground. This mode is sometimes called sourcing.

In negative logic mode, connecting the input to the I/O ground or zero volts will turn the input on. The internal design of this mode is basically a resistor from the input to the positive I/O voltage (usually 12 or 24 volts). This mode is sometime called sinking.

Some of the digital inputs may support high speed input functional such as counting or frequency measurement.

10.7 Analog Inputs

NOTE: See the data sheet for the eXL10 OCS model being used for jumper settings and see the appropriate page in this manual (see Index) for details on how to use Cscape to configure the digital filtering.

The analog inputs on the eXL10 OCS allow voltage or current measurement from a variety of devices. The voltage or current mode is set through jumpers on the unit and settings in Cscape. Each channel can be separately configured for voltage or current mode.

The analog inputs have a digital filter that can be used to filter electrical noise that may be unavoidable in some installations. The downside to digital filtering is the inputs will respond more slowly to sudden changes in the actual input.

10.7.1 Common cause of analog input transorb failure, Models 2,3 & 4

If a 4-20mA circuit is initially wired with loop power but without a load, the analog input could see 24Vdc. This is higher than the rating of the transorb.

This can be solved by not connecting loop power prior to load connection or by installing a low-cost PTC in series between the load and the analog input.

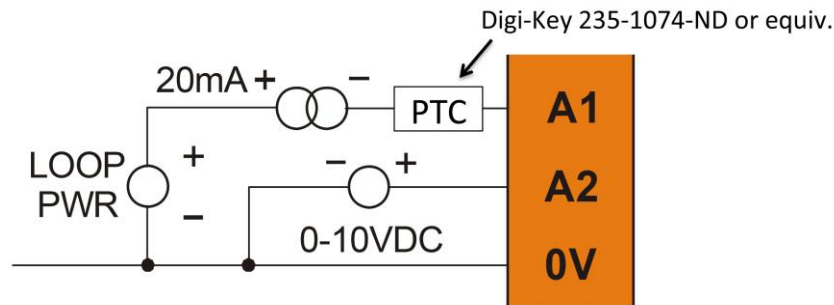

Figure 10.7 – Analog input transorb - troubleshooting

10.8 Universal Analog Inputs Model 5

Note: See the data sheet for the eXL10 OCS model being used for jumper settings and see the appropriate pages in this manual (see [Index](#)) for details on how to use Cscape to configure the digital filtering.

The universal analog inputs provide a high resolution, very flexible interface for a variety of analog inputs. These inputs include voltage, current, thermocouple, RTD and millivolt. Each channel can be configured separately using jumpers and configuration settings in Cscape.

Like the standard analog inputs, these inputs have a digital filter that can be used to filter electrical noise that may be unavoidable in some installations. The downside to digital filtering is the inputs will respond more slowly to sudden changes in the actual input.

10.9 Universal Analog Inputs Model 6

Universal Analog Inputs

The Universal Analog Inputs on the model 6 IO board are unique from other Horner X-series input/output cards in that they are configurable through the module configuration instead of having to change jumper settings in order to setup the input type. To configure the Universal Analog input type:

- 1) Select **Analog In** to access the Analog Input Configuration menu.
- 2) Select any of the Analog input types from the dropdowns by clicking the down arrow beneath each corresponding Channel, as seen below:

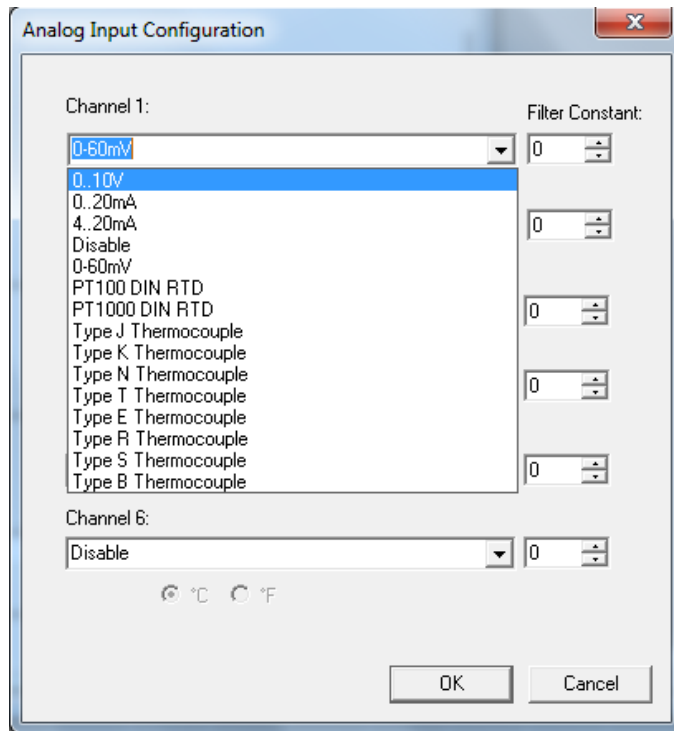

- 3) Ensure the proper wiring is used for each of the 3 pins **A** , **B** , and **C** on the Universal Analog Inputs as seen in the reference image below

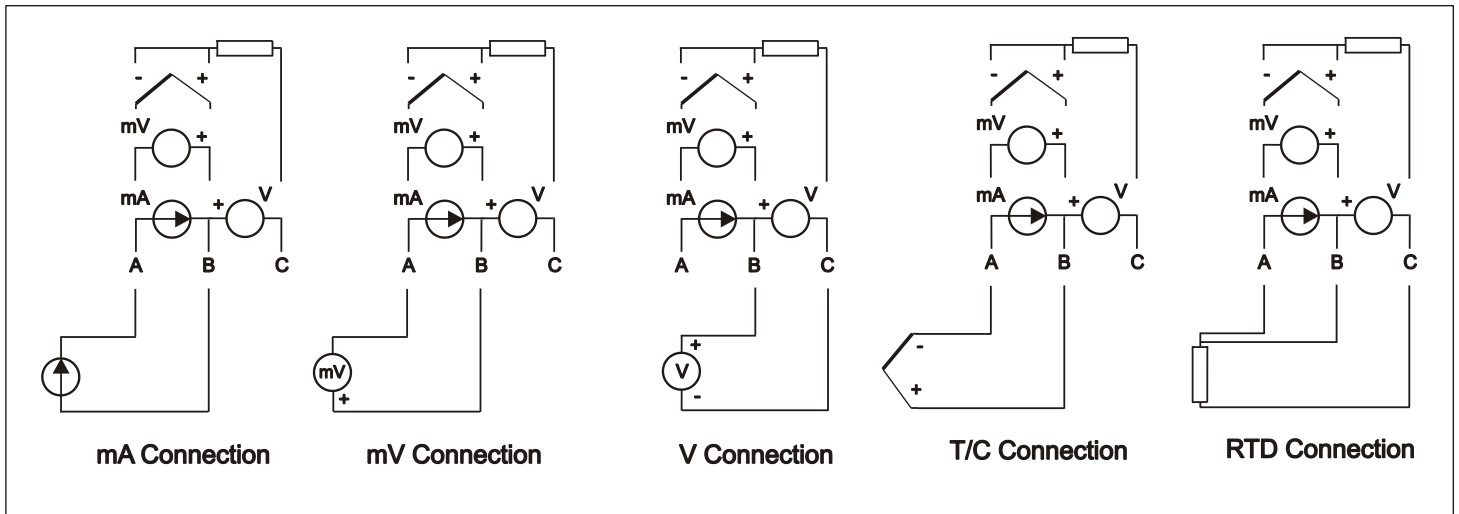

10.10 Analog Outputs

Note: Refer to the datasheet for eXL10 OCS model being used for details on jumper settings. The analog outputs on eXL10 OCS devices provide high resolution voltage or current outputs. The voltage or current selection is controlled with jumpers and configuration settings in Cscape. Note that each channel can be separately configured for voltage or current mode.

When the controller is stopped the operation of each output is configurable. The outputs can hold the state they were in before the controller stopped or they can go to a predetermined value. By default analog outputs are set to a value of zero. For more information on Stop State, refer to the appropriate pages (see [Index](#)) for the configuration chapter for Cscape settings.

CHAPTER 11: HIGH SPEED I/O (HSC / PWM)

11.1 Overview

In addition to the compliment of simple analog and digital I/O, several of the eXL10 OCS I/O modules support High Speed Counting (HSC) I/O functions and may also support Pulse Width Modulation (PWM) Output functions (non-relay modules). The HSC functions include: internal timing, frequency, totalizing, pulse width/period and quadrature measurement. The PWM functions include: traditional PWM (with variable rate and duty cycle) and a stepper (limited functionality) with variable acceleration and deceleration rates. To determine function availability, refer to the associated model's Specification/Installation sheet (Digital DC Input / Output sections.)

This chapter describes the operation of these high level I/O functions. For configuration details of these functions, see Cscape Configuration.

11.2 Glossary

Accumulator	Register used to accumulate or store up a sum or count of many items or events.
Clear	A special function to zero out the value in a specific register. (Not used with Frequency or Period Measurement.)
Disable	A special function to prevent the counter from running.
Encoder	A sensor or transducer for converting rotary motion or position to a series of electronic pulses
Frequency Input	The number of times an electromagnetic signal repeats an identical cycle in a unit of time, usually one second.
Latch (strobe)	A special function that uses a digital logic circuit to store one or more bits. A latch has a data input, a clock input and an output. When the clock input is active, data on the input is "latched" or stored and transferred to the output register either immediately or when the clock input goes inactive. The output retains its value until the clock goes active again.
Marker	Input into the OCS that indicates a particular position. Typically an encoder has a marker output that represents a specific point in the rotation.
Polarity	A Polarity pull-down box is associated with each function and indicates the manner in which the trigger happens (e.g., High level, Low Level, Falling Edge, Rising Edge).
Preload (load)	A special function used to trigger loading of a value into a register upon an event. (Not used with Frequency or Period Measurement.)
Quadrature	A high speed device that expresses the phase relationship between two periodic quantities of the same period when the phase difference between them is one fourth of a period. A coupler in which the two output signals are 90° out of phase.
Totalizer	A counter that sums the total number of cycles applied to its input.

Table 11.1 – Glossary of High Speed I/O Terms

11.3 High Speed Counter (HSC) Functions

The eXL10 supports two very high speed, configurable counters. There are four dedicated inputs that can be configured to a number of different options. Each of the two counters can run in one of five modes. Those modes are Totalizer, Frequency Counter, Pulse Width Measurement, Period Measurement and Quadrature measurement. For some modes, more than one HSC input may be consumed. The measurement values are provided to ladder in a %AI register (see page 49).

11.3.1 Frequency

In frequency mode, the frequency of the input signal is written to the accumulator in terms of Hertz (cycles/second). When using frequency mode, four update selections are provided which specify the width of the sample window. Note that selecting a shorter sample window provides a quicker measurement (faster response) but lowers the frequency accuracy (resolution) and increases the minimum frequency measurement limit. In this mode the Disable and Latch special functions are allowed. Please see section 11.2 for a description of these functions.

11.3.2 Totalize

In totalize mode, the accumulator is simply incremented or decremented each time the input transitions in a specific direction.

The totalizer supports the following modes:

Internal	This mode ties the input to the counter to an internal 10MHz or 1MHz clock. The special functions can be used to accurately time events.
Count Up	This increments the accumulator when the input is enabled. Note that two inputs can be assigned. Either input can cause the counter to increment. The second input can also be disabled.
Count Down	This decrements the accumulator when the input is enabled. Note that two inputs can be assigned. Either input can cause the counter to decrement. The second input can also be disabled.
Up/Down (Input 1 Up/Input 2 Down)	In this mode, input 1 (assigned to any of the four inputs) increments the counter, while input 2 (also assigned to any of the 4 inputs) decrements the counter.
Clk/Dir (Input 1 Clk, Input 2 Dir)	This mode uses input 1 as a clock signal to increment or decrement the counter and then uses input 2 to decide the direction. Input 2 disabled increments the counter, while input 2 enabled decrements the counter.

NOTE: the totalize mode enables the Disable, Latch, Preload, and Clear special functions. Please see section 11.2 for details.

11.3.3 Pulse Width Measurement

In pulse width measurement mode, the high-speed input can measure the width of a pulse stream in one of two modes and provides a continuous indication of the last sampled value. In this mode the Disable and Latch special functions are allowed. Please see section 11.2 for a description of these functions.

Width High 1 μ s Counts – In this sub-mode the accumulator value will contain the number of 1 μ s counts the pulse is high.

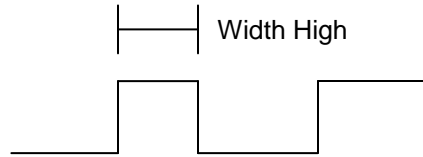

Width Low 1 μ s Counts - In this sub-mode the accumulator value will contain the number of 1 μ s counts the pulse is low.

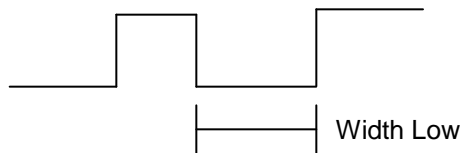

Figures 11.1-11.2 - Pulse Width Measurements, High & Low

11.3.4 Period Measurement

In period measurement mode, the high-speed input can measure the period of a pulse stream in one of two modes and provides a continuous indication of the last sampled value. In this mode the Disable and Latch special functions are allowed. Please see section 11.2 for a description of these functions.

Period Rising Edges 1 μ s Counts – In this sub-mode the period of the input signal is reported in one (1) μ s units. The period measurement will start on the rising edge of the input.

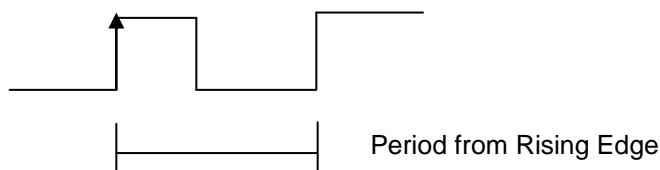

Period Falling Edges 1 μ s Counts – In this sub-mode the period of the input signal is reported in one (1) μ s units. The period measurement will start on the falling edge of the input.

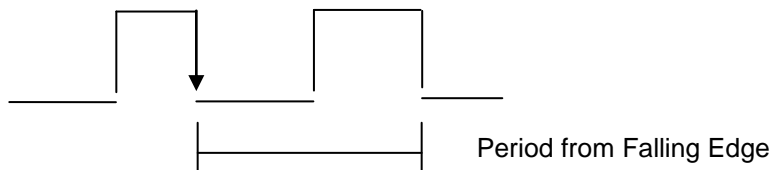

Figures 11.3-11.4 – Period Measurement, Rising Edges & Falling Edges

11.3.5 Quadrature

Quadrature mode uses two HSC inputs, any of the four HSC inputs can be assigned for this purpose.

Quadrature mode works much like the totalizer except the accumulator will automatically increment or decrement based on the rotation phase of the two inputs. See the following example for more details. Quadrature inputs are typically used for reporting the value of an encoder.

Two modes are available for quadrature that select whether the accumulator counts up or down when the phase of input 1 leads input 2. Check your encoder’s documentation to determine the output form it uses or try both modes to determine if the encoder counts up when expected.

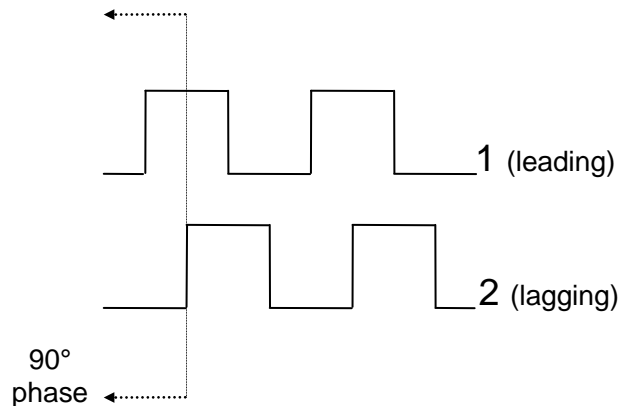

Figures 11.5 – Quadrature

Using the above waveforms and a HSC input configuration of “Quadrature” - “1 leads 2, count up,” the accumulator will count up when 1 is rising and 2 is low, 1 is high and 2 is rising, 1 is falling and 2 is high, and when 1 is low and 2 is falling. This results in 4 counts per revolution. So in order to determine the number of cycles, the accumulator would have to be divided by 4.

Marker reset operation is configured in the special operations and can be assigned to any of the 4 high speed inputs or can be assigned to be controlled by a “Q” bit in ladder.

Note, the quadrature mode enables the Disable, Latch, Preload, Clear and Marker special functions. Please see section 11.2 for details.

11.3.6 Register Match

All counter modes support a register match function. When the accumulator value matches the Match 1 or Match 2 value setup in %AQ registers a high speed output with either turn on, turn off or toggle based on settings in Cscape.

11.4 HSC Functions Register Map

The register assignments for the high speed I/O can be moved via a setting in Cscape. The values shown are the DEFAULT values and may not match the same starting point as the values shown below.

Table 11.2 – HSC Functions Register Map				
Register	Frequency	Pulse	Totalize	Quad
%AI401-402			Accumulator - Counter 1	
%AI403-404			Latch Value – Counter 1	
%AI405-406			Accumulator – Counter 2	
%AI407-408			Latch Value – Counter 2	
Counter 1				
%AQ401-402			Preload – Counter 1	
%AQ403-404			Match1 – Counter 1	
%AQ405-406			Match2 – Counter 1	
%AQ401-402			Preload – Counter 2	
%AQ403-404			Match1 – Counter 2	
%AQ405-406			Match2 – Counter 2	
Counter 2				
%Q1601			Latch – Counter 1	
%Q1602			Preload – Counter 1	
%Q1603			Clear – Counter 1	
%Q1604			Disable – Counter 1	
%Q1605			Direction – Cnt 1	
%Q1606			Output Reset – Counter 1	
%Q1607			Preload Disable – Counter 1	
%Q1608			Latch Disable – Counter 1	
%Q1609				Disable Marker – C1
%Q1610				Latch Marker – C1
%Q1611				Preload Marker – C1
%Q1612				Clear Marker – C1
%Q1613-1616			Reserved	
%Q1617			Latch – Counter 2	
%Q1618			Preload – Counter 2	
%Q1619			Clear – Counter 2	
%Q1620			Disable – Counter 2	
%Q1621			Direction – C2	
%Q1622			Output Reset – Counter 2	
%Q1623			Preload Disable – Counter 2	
%Q1624			Latch Disable – Counter 2	
%Q1625				Disable Marker – C2
%Q1626				Latch Marker – C2
%Q1627				Preload Marker – C2
%Q1628				Clear Marker – C2
Counter 3				
%I1601			Overflow Flag – Counter 1	
%I1602			Underflow Flag – Counter 1	
%I1603			High Speed Out 1	
%I1604			Reserved	
%I1605			Overflow Flag – Counter 2	
%I1606			Underflow Flag – Counter 2	
%I1607			High Speed Out 2	
%I1608			Reserved	

11.5 High Speed Output Functions

On units that support High Speed Output functions, two dedicated outputs are available that can be configured for one of four modes of operation. Those modes are Normal, PWM, HSC Match and Stepper.

11.5.1 Normal

When either Q1 or Q2 is configured for Normal operation, the digital output registers %Q1 and %Q2 drives that respective output.

11.5.2 PWM

When either Q1 or Q2 is configured for PWM, the PWM function drives that respective output. Both PWM channels may be individually enabled and can have independent frequency and duty cycles.

The PWMs require two parameters (%AQs) to be set for operation. These parameters may be set at run-time.

Duty Cycle - The Duty Cycle is a 32 bit value from 0 to 32,000 indicating the relative duty cycle of the output. For example a value of 8000 would indicate a 25% duty cycle, a value of 16,000 would indicate a 50% duty cycle. 0 turns the output off, 32,000 turns the output on.

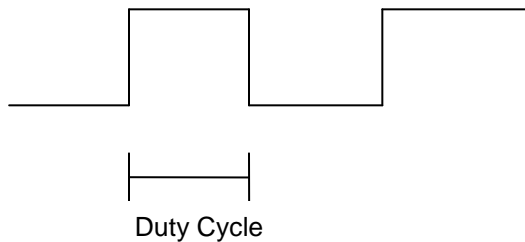

Frequency - The Frequency is a 32 bit value indicating the output frequency in Hertz. One over the frequency is the period.

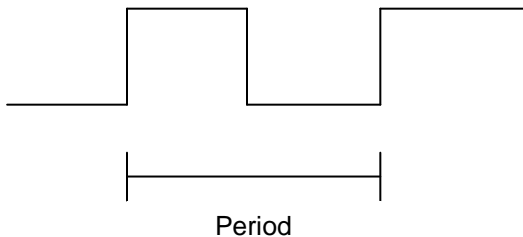

Figures 11.6 & 11.7 – PWM, two parameters, Duty Cycle & Frequency

At controller power-up or during a download, the PWM output is maintained at zero until both the Frequency and the Duty cycle are loaded with non-zero values. When the controller is placed in stop mode, the state of the PWM outputs is dependent on the *PWM State on Controller Stop* configuration. This configuration allows for either hold-last-state or specific frequency and duty cycle counts. Specifying zero for either the period or duty causes the PWM output to remain low during stop mode.

NOTE: for standard I/O modules (1E3, 1E4 and 1E5 models,) the maximum recommended PWM frequency is 5000Hz, due to the limitations of built-in output circuitry. The **HE-XHSQ** generates 24V pulse outputs with a recommended max of 400,000Hz. The **HE-XHSQ-5** generates 5V pulse outputs with a recommended max of 1.0MHz. The addon HSQ and HSQ-5 module can be added to the 1E2 unit for HSC function.

11.5.3 High Speed Counter Match

When either Q1 or Q2 is configured for HSC Output operation, their output state is based on a comparison between the counter accumulator and match registers. See details above in the high speed input section.

11.5.4 Stepper Function

The eXL10 supports two stepper functions, one on each high speed output.

The Stepper requires five parameters (%AQs) to be set for operation. These parameters may be set at run-time but are 'latched' when the stepper is commanded to start:

Start Frequency <i>(pulses per second)</i>	Sets the frequency for the first cycle during the acceleration phase and the frequency of the last cycle during the deceleration phase. When an acceleration or deceleration count is specified, the Start Frequency must be greater than 0 and must not exceed the run frequency or an error is generated.
Run Frequency <i>(pulses per second)</i>	Sets the frequency for the last cycle during the acceleration phase, the consistent frequency during the run phase, and the frequency of the first cycle during the deceleration mode. The Run Frequency must be greater than 0 and must not exceed 5000Hz (standard), 400,000Hz (HE-XHSQ) or 1.0 MHz (HE-XHSQ-5)
Acceleration Count	Sets the number of cycles to occur within the acceleration phase. The frequency of the cycles within this mode will vary linearly between the specified Start and Run frequency. The Accel count must not equal 1 or an error is generated. Setting this value to zero disables this phase.
Run Count	Sets the number of cycles to occur within the run phase. The frequency of the cycles within this mode is constant at the specified Run frequency. The Run count may be any value. Setting this value to zero disables this phase.
Deceleration Count	Sets the number of cycles to occur within the deceleration phase. The frequency of the cycles within this phase will vary linearly between the specified Run and Stop frequency. The Decel count must not equal 1 or an error is generated. Setting this value to zero disables this phase.

The stepper provides two Boolean registers to provide stepper status:

Ready/Done	A high indication on this register indicates the stepper sequence can be started (i.e. not currently busy) and also when the move is completed.
Error	A high indication on this register indicates that one of the analog parameters specified above is invalid or the stepper action was aborted before the operation was complete. This register is cleared on the next start command if the error was corrected.

The stepper requires one discrete register to control the stepper action. Setting this register starts the stepper cycle. This register must remain set to complete the entire cycle. Clearing this register before the cycle is complete aborts the step sequence and sets the error bit.

NOTE: Setting the PLC mode to stop while the stepper is in operation causes the stepper output to immediately drop to zero and the current stepper count to be lost.

NOTE: The stepper output level may cause damage or be incompatible with some motor drive inputs. Consult drive documentation to determine if output level and type is compatible.

11.6 High Speed Output Functions Register Map

The register assignments for the high speed I/O can be moved via a setting in Cscope. The values shown are the DEFAULT values and may not match the same starting point as the values shown below.

Table 11.3 – PWM Functions Register Map		
Register	PWM	Stepper
%AQ421-422	PWM 1 Duty Cycle (32-bit)	Start Frequency – Stepper 1
%AQ423-424	PWM 1 Frequency	Run Frequency – Stepper 1
%AQ425-426		Acceleration Count – Stepper 1
%AQ427-428		Run Count – Stepper 1
%AQ429-430		Deceleration Count – Stepper 1
%AQ431-432	PWM 2 Duty Cycle (32-bit)	Start Frequency – Stepper 2
%AQ433-434	PWM 2 Frequency	Run Frequency – Stepper 2
%AQ435-436		Acceleration Count – Stepper 2
%AQ437-438		Run Count – Stepper 2
%AQ439-440		Deceleration Count – Stepper 2
Stepper 1		
%Q1*		Start Move Bit – Stepper 1
%Q2*		Start Move Bit – Stepper 2
Stepper 2		
%I1617		Ready/Done – Stepper 1
%I618		Error – Stepper 1
%I1619		Ready/Done – Stepper 2
%I620		Error – Stepper 2

*Q30 and Q31 for model 2 using HSQ or HSQ-5 (necessary to start move)

11.7 PWM Examples

Example 1	Duty Cycle	Frequency
To get a 50% Duty Cycle @ 10 kHz waveform on PWM1:	Set %AQ421-422 = 16,000	Set %AQ423-424 = 10,000

Example 2	Duty Cycle	Frequency
To get a 50% Duty Cycle on PW1 and 90 % Duty Cycle on PWM2 @ 1 kHz waveform:	Set %AQ421-422 = 16,000	Set %AQ423-424 = 1,000
	Set %AQ431-432 = 28,800 <i>(duty cycle (32000 * 0.9))</i>	Set %AQ433-434 = 1,000

Example 3	Duty Cycle	Frequency
To turn PWM 1 output ON all the time	Set %AQ421-422 = 32,000	Set %AQ423-424 = Any Value

Example 4	Duty Cycle	Frequency
To turn PWM 1 output OFF all the time	Set %AQ421-422 = 0	Set %AQ423-424 = Any Value

11.8 STP Examples

Example 1	Start Frequency	Run Frequency	Accel Count	Run Count	Decel Count
10,000,000 steps control sequence	Set %AQ421 = 2500 (Hz)	Set %AQ422 = 5000 (Hz)	Set %AQ423-4 = 1,000,000 (Steps)	Set %AQ425-6 = 8,000,000 (Steps)	Set %AQ427-8 = 1,000,000 (Steps)

When the start bit is energized, the example starts at 2.5 kHz and ramps up to 5 kHz during the first 1,000,000 steps. Then, it runs at 5 kHz for the next 8,000,000 steps. Finally during the last 1,000,000 steps it slows to a stop.

Example 2	Start Frequency	Run Frequency	Accel Count	Run Count	Decel Count
5,000,000 steps control sequence	Set %AQ421 = 500 (Hz)	Set %AQ422 = 1000 (Hz)	Set %AQ423-4 = 2,000,000 (Steps)	Set %AQ425-6 = 2,000,000 (Steps)	Set %AQ427-8 = 1,000,000 (Steps)

When the start bit is energized, the example starts at 0.5 kHz and ramps up to 1 kHz during the first 2,000,000 steps. Then, it runs at 1 kHz for the next 2,000,000 steps. Finally during the last 1,000,000 steps it slows to a stop.

Example 3	Start Frequency	Run Frequency	Accel Count	Run Count	Decel Count
6,000,000 steps control sequence	Set %AQ421 = 50 (Hz)	Set %AQ422 = 250 (Hz)	Set %AQ423-4 = 150,000 (Steps)	Set %AQ425-6 = 5,500,000 (Steps)	Set %AQ427-8 = 350,000 (Steps)

When the start bit is energized, the following example starts at 50 Hz and ramps up to 250 Hz during the first 150,000 steps. Then, it runs at 250 Hz for the next 5,500,000 steps. During the last 350,000 steps it slows to a stop.

Note: Prior to the start of a move, the Ready/Done bit for that channel must be ON (%I1617 or %I1619 for channel 1 and 2 respectfully). The Ready/Done bit will turn OFF during the move, and then back ON once the move is completed.

Note: The pulse generation hardware on the eXL10 can generate any frequency that can be evenly divided into 10Mhz (10,000,000 Hz) under the maximum recommended frequencies for each model. This results in a very smooth operation at lower frequencies, with a progressively choppier operation at higher frequencies, as the units reach their maximum recommended frequency.

CHAPTER 12: SYSTEM SETTINGS AND ADJUSTMENTS



12.1 System Menu - Overview

The eXL10 has a built-in System Menu, which lets the user view System Settings and makes adjustments. To start the System Menu, press the SYSTEM key (or set %SR3 to 1), which will display the Main Menu. Then use the ↓ and ↑ (Up Arrow or Down Arrow) keys to select a **Main Menu** item and press **Enter** (Return Arrow) to display the item's Sub-Menu.

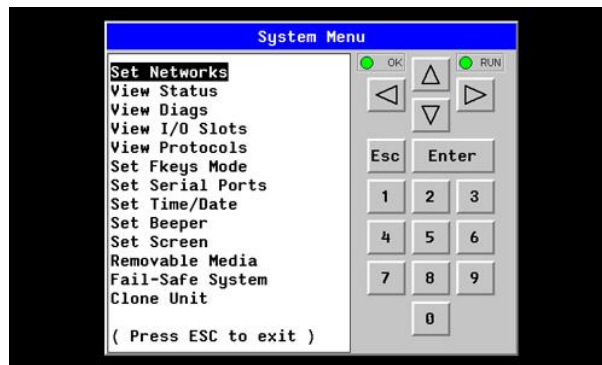



Figure 12.1 – System Menu (eXL10) Screenshot

12.2 System Menu – Navigation and Editing

As mentioned above, the System Menu is started by pressing the System key on the eXL10. Next press **ESC** to exit the System Menu, or use ↓ and ↑ to select an item and press **Enter** to display the item's Sub-Menu.

A Sub-Menu generally shows a list of System Settings and their values. After opening a Sub-Menu, if any of its System Settings are editable, the first System Setting that can be edited is highlighted. If desired, the ↓ and ↑ keys can be used to select a different System Setting to be edited.

At this point, either press **ESC** to exit the Sub-Menu (returning to the Main Menu) or press **Enter** to edit the highlighted System Setting. If **Enter** is pressed, the System Setting's value will be highlighted, indicating that it is ready to be modified.

When modifying a System Setting's value, use either the arrow keys (← → ↓ ↑)  or the numeric keys, or the appropriate touch screen icons to select a new value.

The arrow keys are used to edit System Settings that have just a few possible values. Each time the arrow key is pressed, a new possible value is displayed. When the desired value appears, press the **Enter** key to save it; otherwise press the **ESC** key to cancel the edit.

The numeric keys are normally used to enter numeric System Settings.



In addition, to edit a single numeric digit, use the ← or → key to select the digit and then either press a numeric key or use ↓ or ↑ to modify the digit. In any case, after entering the new desired value, press the **Enter** key to save it; otherwise press the **ESC** key to cancel the edit.

12.3 System Menu – Details

The following sections describe each of the Sub-Menus in detail.

Set Networks

This sub menu allows setting for the CAN and Ethernet network to be viewed or changed.

CAN Ok?	Yes= CAN1 connected to a CAN network and functioning properly No= Not ready to communicate on CAN network	
CAN ID	1 to 253 = This node’s CsCAN Network ID; must be unique on network	
CAN Baud	125 KB = 125 Kbaud CAN network 250 KB = 250 Kbaud CAN network	500 KB = 500 Kbaud CAN network 1 MB = 1 Mbaud CAN network
MAC ID	Displays the Ethernet MAC ID of the unit	
IP	Displays the Ethernet IP address of the unit	
NetM	Displays the Ethernet net mask of the unit	
GatWy	Displays the Ethernet gateway of the unit	

NOTE: The IP address, Net Mask and Gateway can be changed from the system menu. This is designed for commissioning or temporary field changes. The actual parameters are defined in Cscope under the Ethernet configuration and are reverted to whenever the unit goes from idle to run mode.

View Status

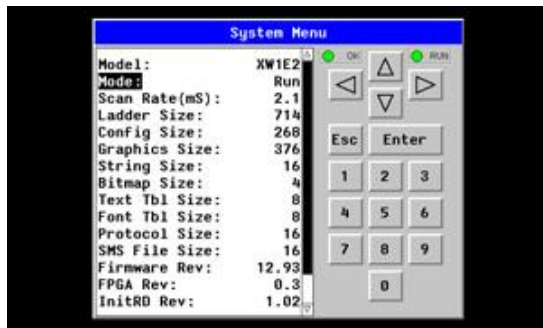

The View Status Sub-Menu displays up to 19 System Settings. Only the **OCS Mode** System Setting is editable.

Model	XW1yz = Model number of this eXL10 OCS unit 1yz = indicates the installed I/O module 00 = no I/O module
OCS Mode	Idle = EXL10 OCS is in Idle mode DoIO = EXL10 OCS is in Do I/O mode Run = EXL10 OCS is in Run mode
Scan Rate(mS)	0.0 = EXL10 OCS is not in Run mode 0.1 to 999.9 = Average number of mS for each ladder scan
OCS Net Use %	0.0 to 100.0 = CAN network bandwidth % used by this eXL10 OCS node
All Net Use %	0.0 to 100.0 = CAN network bandwidth % used by all nodes
Ladder Size	x = Number of bytes in application ladder program
Config Size	x = Number of bytes in application I/O configuration
Graphics Size	x = Number of bytes in application graphic screens
String Size	x = Number of bytes in application string table
Bitmap Size	x = Number of bytes in application bitmaps

Text Tbl Size	x = Number of bytes in application text tables
Font Tbl Size	x = Number of bytes in application font tables
Protocol Size	x = Number of bytes in application downloaded protocols
SMS File Size	x = Number of bytes in application SMS protocol configuration
Firmware Rev	xx.yy = Current firmware version
OS Ver	a.b.cd.yz = Current Operating System version
FPGA Rev	x.y = Current FPGA version (High Speed IO Sub System)
InitRD Rev	x.yz = Bootloader version
Self-Test	Ok = All power-on self-tests passed Fault = One or more power-on self-tests failed

View Diags



The View Diags Sub-Menu displays up to 11 System Diagnostics, none of which are editable.

The first two System Diagnostics are critical. If either of these indicate a Fault condition, the eXL10 OCS will not enter or remain in Run mode, and the problem must be investigated and corrected.

Logic Error:	Ok = All executed ladder instructions are legal for loaded firmware Fault = A ladder instruction <u>not</u> supported by firmware was found
User Program:	Ok = Ladder program and I/O configuration loaded successfully Fault = Ladder program or I/O configuration not loaded or load failed

The last nine System Diagnostics are informational. If any of these indicate a warning condition, the eXL10 OCS can still enter and remain in Run mode, but the problem should be investigated and corrected.

User Graphics	Ok = Application graphics objects loaded successfully Fault = Application graphics objects not loaded or load failed
W-Dog Trips	0 = Watchdog timer has not tripped since the last power-up x = Number of times watchdog timer has tripped
Net Errors	0 = No CAN network bus-off errors have occurred x = Number of CAN network bus-off errors that have occurred
Network State	Ok = At least one other node was found on the CAN network Warning = No other nodes were found on the CAN network
Network ID	Ok = This node's CAN Network ID is in the range 1 to 253 Warning = This node's CAN Network ID was out of range at power-up
Dup Net ID	Ok = This node's Network ID is unique on the CAN network Warning = This node's Network ID is duplicated in another node

Clock Error	Ok = Time and date have been set Warning = Time and date need to be set
I/O System	Ok = I/O configuration matches the installed I/O and COM modules Warning = I/O configuration needs updating to match installed modules
Battery	Ok = Backup battery operating properly Warning = Backup battery needs to be replaced

View I/O Slots

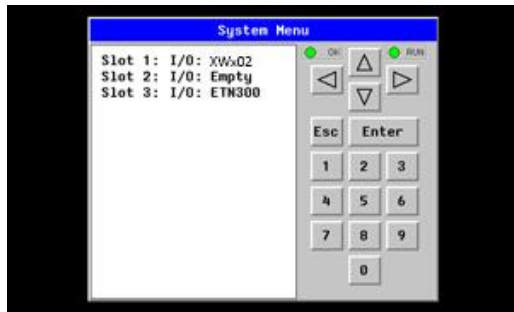

The View I/O Slots Sub-Menu displays three System Settings, none of which may be edited.

Internal to the eXL10 OCS, there is a CPU board, and up to two installed modules. Model HE-EXV1E0 / HEXT505C100W100 has no installed I/O or COM modules. All other models have an I/O module and can have a user-installed COM module.

Depending on which I/O module is installed and which I/O module has been configured by Cscape, one of the following six System Settings should appear for Slot 1:

Slot 1: I/O: Empty	= No I/O module installed or configured
Slot 1:*Unsupported	= Unsupported I/O module installed
Slot 1:-I/O Missing	= No I/O module installed but an I/O module is configured
Slot 1:+I/O: XExyy	= yy I/O module installed but no I/O module configured
Slot 1:?!I/O: XExyy	= yy I/O module installed but another I/O module configured
Slot 1: I/O: XExyy	= yy I/O module installed and configured properly

Depending on the COM module that is installed and the COM module that has been configured by Cscape, one of the following six System Settings appears for Slot 2:

Slot 2: I/O: Empty	= No COM module installed or configured
Slot 2:*Unsupported	= Unsupported COM module installed
Slot 2:-I/O Missing	= No COM module installed but a COM module is configured
Slot 2:+I/O: XzC	= z COM module installed but no COM module configured
Slot 2:?!I/O: XzC	= z COM module installed but another COM module configured
Slot 2: I/O: XzC	= z COM module installed and configured properly

Slot 3: I/O: ETN300	= ETN300 has been configured through Cscape
----------------------------	---

View Protocols

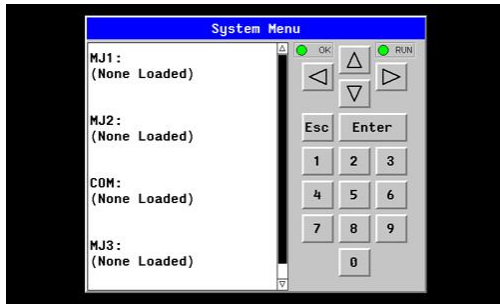

The View Protocols Sub-Menu displays two System Settings, neither of which may be edited.

As mentioned in 0, both the MJ1/MJ2 (Port 1) and MJ3 (Port 2) serial ports support downloadable protocols. To assign a downloadable protocol to an eXL10 OCS serial port, select the **Protocol Config** item in Cscape’s Program menu and then set up a protocol for Port 1 or Port 2 (or both).

In the View Protocols Sub-Menu, the currently downloaded protocol, if any, and its version number are displayed for each of MJ1, MJ2 COM board and MJ3.

Set Fkeys Mode

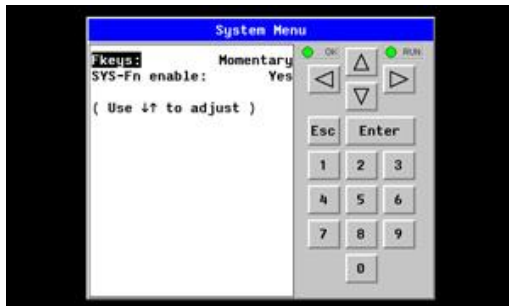

The Set Fkeys Sub-Menu displays two System Settings, both of which may be edited.

Fkeys	Momentary = %K1-5 bits go On & Off as F1-F5 are pressed & released Toggle = %K1-5 bits toggle each time F1-F4 are pressed
SYS_Fn enable	Yes = Reset and all clear system functions enabled No = Reset and all clear system functions disabled

Set Serial Ports



The Set Serial Ports Sub-Menu displays three System Settings, all of which may be edited, and one optional item. For the **Dflt Pgm Port** System setting, only MJ1-232 can be selected, unless a Modem (XMC) COM module is installed.

Dflt Pgm Port	MJ1-232 = MJ1 RS232 port is the default programming port Modem = Modem COM module is the default programming port
MJ2 RS485 Bias	No = MJ2 RS485 bias resistors are <u>not</u> switched in Yes = MJ2 RS485 bias resistors are switched in
MJ3 RS485 Bias	No = MJ3 RS485 bias resistors are <u>not</u> switched in Yes = MJ3 RS485 bias resistors are switched in

Set Time/Date



The Set Time/Date Sub-Menu displays three System Settings. **Time** and **Date** may be edited, and **Day** is automatically calculated from the **Date** setting. Note that **Time** and **Date** are split into three fields each, all of which may be edited. Use ← or → to select a field and then use ↓ or ↑ to edit the field.

Time	16:09:49 = Current time (hours:minutes:seconds in 24-hour format)
Date	10-Jun-2013 = Current date (day-month-year)
Day	Monday = Current day of week calculated from the Date setting

Set Beeper



The Set Beeper Sub-Menu displays one System Setting, which may be edited.

Beeper enable	Yes (<i>default</i>) = Enables beeper No = Disables beeper (<i>does NOT affect ladder access</i>)
----------------------	--

Set Screen

The Set Screen Sub-Menu displays four System Settings, all of which may be edited.



Saver enable	Yes = Enable screen saver No (<i>default</i>) = Disable screen saver
Timeout (min)	5 - 1200 = Amount of time in minutes to expire with NO touch activity before activating screen saver (black screen)
Popup Status	Off (<i>default</i>) = Disable popup status Warning = Display popup status only if controller status changes to NOT Ok or NOT Run mode. On = Display popup status on any controller status change.
Update Time (mS)	2 - 50 = Maximum amount of time to allow for graphics update per scan

Removable Media

Media Directory				
SCR0000	.JPG	26267	07-10-08	12:46
SCR0001	.JPG	14272	07-10-08	12:46
SCR0002	.JPG	15209	07-10-08	12:46
SCR0003	.JPG	29708	07-10-08	12:46
SCR0004	.JPG	29582	07-10-08	12:47
SCR0005	.JPG	23263	07-10-08	12:47
SCR0006	.JPG	14643	07-10-08	12:47
SCR0007	.JPG	14976	07-10-08	12:47
SCR0008	.JPG	15994	07-10-08	12:47
SCR0009	.JPG	17561	07-10-08	12:47

Free: 511672320 Total: 511959040

The Removable Media Sub-Menu displays the Removable Media Manager. Having selected Removable Media from the Main Menu, one of four Sub-Menu screens will appear:



= No MicroSD card has been installed in the Memory slot



= MicroSD card is installed, but it is still initializing



= MicroSD card is installed and initialized, but contains no files

Media Directory				
SCR0000	.JPG	26267	07-10-08	12:46
SCR0001	.JPG	14272	07-10-08	12:46
SCR0002	.JPG	15209	07-10-08	12:46
SCR0003	.JPG	29708	07-10-08	12:46
SCR0004	.JPG	29582	07-10-08	12:47
SCR0005	.JPG	23263	07-10-08	12:47
SCR0006	.JPG	14643	07-10-08	12:47
SCR0007	.JPG	14976	07-10-08	12:47
SCR0008	.JPG	15994	07-10-08	12:47
SCR0009	.JPG	17561	07-10-08	12:47

Free: 511672320 Total: 511959040

= MicroSD card is installed and initialized, and it contains files

- Shows size of highlighted file or shows <DIR> if directory is highlighted
- Shows the date file or directory was created or last modified
- Shows the time file or directory was created or last modified

If a directory name is highlighted, pressing **Enter** will switch to that directory showing its files and sub-directories. In a sub-directory, highlighting “..” (dot dot) and pressing **Enter** will move up one directory.

Fail – Safe System

The Fail-Safe System is a set of features that allow an application to continue running in the event of certain types of "soft" failures. These "soft" failures include:

- Battery power loss
- Battery-Backed Register RAM or Application Flash corruption due to, for example, an excessive EMI event.

Selecting “Fail-Safe System” menu will open the following menu screen:

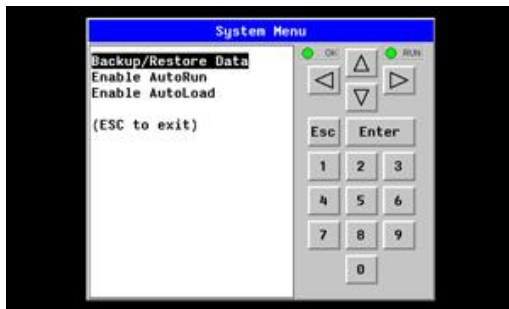

Selecting Backup/Restore Data displays the following screen in:



Backup	= Copies Battery Backed RAM contents on to the onboard FLASH memory of the OCS.
Restore	= Copies the backed up data from onboard FLASH to the battery backed RAM.
Clear Backup	= The backup data will be erased from the onboard FLASH.
Exit	= Goes back to previous menu

“Enable AutoRun” displays the following options which can be selected:



<p>Enable AutoRun</p>	<p>No = OCS will be in IDLE mode after AutoLoad or Automatic Restore. Yes = OCS will automatically be placed into RUN mode after AutoLoad or Automatic Restore.</p>
------------------------------	--

“Enable AutoLoad” displays the following options which can be selected:

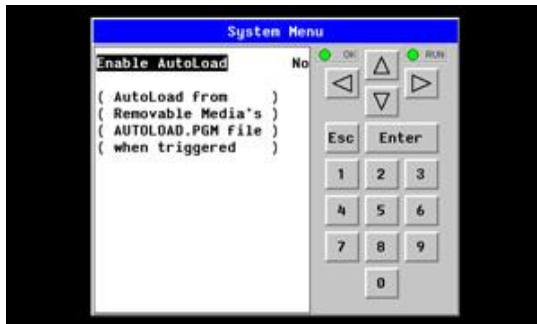

<p>Enable AutoLoad</p>	<p>No = Does not load AUTOLOAD.PGM automatically when application program is absent or corrupted. Yes = Loads AUTOLOAD.PGM file automatically from RM when application program is absent or corrupted.</p>
-------------------------------	---

Clone Unit

‘Clone Unit’ feature allows the user to “clone” the OCS of the exact same model. This feature “clones” application program and unit settings stored in Battery backed RAM of an OCS into the RM (refer Removable Media [Chapter 9](#) for details on using RM). It can then be used to clone a different OCS (exact same model).

This feature can be used when:

- Replacing an OCS by another unit of the same model.
- Duplicating or “clone” units without a PC.

Clone

Selecting “Clone Unit” menu will open the following menu screen:

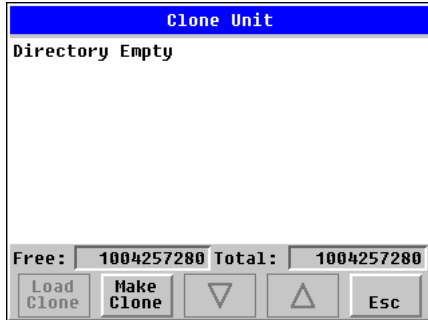

Note: Free/Total – displays number of free and total bytes in Removable Media.

Selecting Make Clone brings up the confirmation screen. Upon confirmation, the OCS will create two new files in the root directory of the Removable Media Drive as shown below:

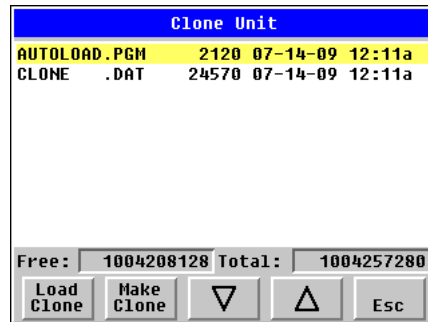
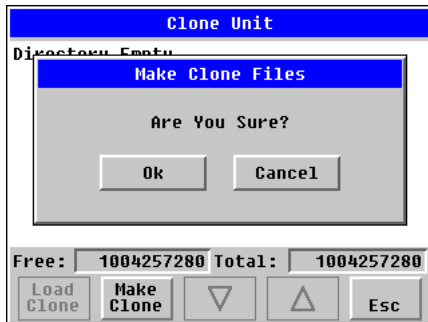

AUTOLOAD.PGM	Application file
CLONE.DAT	File having all unit settings and register values from Battery Backed RAM

Load Clone

Selecting “Clone Unit” menu will open the following menu screen. Select “Load Clone”.

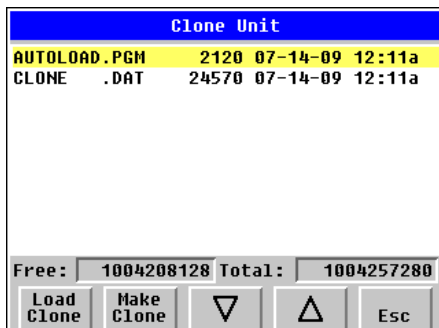

NOTE: For security enabled files, Load clone asks for password validation before loading the application.

12.4 Touch screen calibration

The touch screen is calibrated at the factory and rarely needs modification. However, if actual touch locations do not appear to correspond with responding objects on the display, field adjustment is available. To access the field adjustable touch screen calibration dialog, press and hold both the SYS and F1 key for longer than 2 seconds and a dialog similar to figure 9.2 should appear. Thereafter, use a plastic tip stylus and follow the dialog instructions.

Note that special system keys may be locked out from user access. If the SYS-F1 combination does NOT respond, verify that the system menu's Set Fkeys sub-menu's parameter SYS_Fn is enabled.



CHAPTER 13: USER INTERFACE

13.1 Overview

This chapter presents the user interface (or operator view) of the eXL10 and some of the model specific characteristics of the eXL10 as compared to the rest of the OCS line. This chapter does NOT cover building screens or using the Cscape graphics editor. For instructions on creating screens and using the graphics editor, refer to the graphics editor help file.

The following aspects are discussed:

- Displaying and entering data
- Alpha-numeric data entry
- Navigating around screens
- Beeper acknowledgement
- Touch (slip) sensitivity
- Alarm log dialog
- RM dialog
- Screen Saver
- Dimmer

13.2 Displaying and entering Data

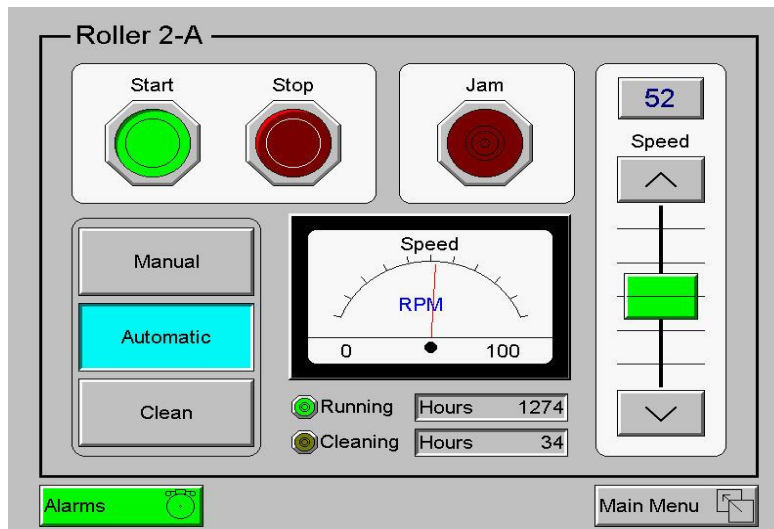

Figure 13.1 – Example Screen

Multiple objects are provided for displaying data such as virtual panel lights, push buttons, numeric value displays, bar graphs, meters, graphs and animated bitmaps. On the eXL10, these graphical objects (through ladder manipulation of attribute bits) can change color, flash or change visibility to attract operator attention.

On objects that accept user input, the input is provided by touching the object or alternately changing an OCS register (i.e. Function key registers). Objects that allow input generally have a raised 3D appearance. An exception is the binary type objects, such as buttons, which are shown in a depressed 3D appearance when in the ON state. Objects that normally accept touch input may be disabled through program control (through ladder manipulation of an attribute bit). If an object is disabled, the object's representation changes to a 2D appearance.

On objects that represent non-discrete information, more action may be required beyond that of simply touching the object. For example, the slider object requires the operator to touch and *slide* the control in

the direction desired. Alternately, alpha-numeric entry objects invoke a pop-up alpha-numeric keypad for additional user input. The alpha-numeric keypad is discussed below.

Note that if the numeric entry object displays >>>>>>, the value is too big to display in the field or is above the maximum for an editable field. Likewise, if the numeric entry object displays <<<<<< in a numeric field, the value is too small to display or is below the minimum for an editable field.

13.3 Alpha-numeric keypad

To allow entry of a specific number or text, several of the input objects invoke a pop-up alpha-numeric keypad when the object is touched. An example of the alpha-numeric keypad invoked from a numeric input object is shown in Figure 13.2. Once invoked, the operator may touch the appropriate keys to enter a specific value. When entering a value, the alpha-numeric keypad is in one of two modes [new-value or edit-value].

New-value mode

Generally, when the alpha-numeric keypad is first invoked, it is placed in new-value mode. Initially, the alpha-numeric keypad displays the current value with all the digits being highlighted. Once the first digit is entered, the current value is erased from the display and the new digit is placed in the first location. Thereafter, no digits are highlighted and new digits are added to the rightmost position while the other digits are shifted left.

Edit-value mode

Edit-value mode may be entered from the initial new-value mode by pressing either the left or right arrow key before any digit key is pressed. The result will be a single character highlighted. The user may then either touch a key to change the digit at the selected position or the up and down arrows may be used to add or subtract (respectively) from the selected digit. The user may then use the left or right arrow keys to select a new position.

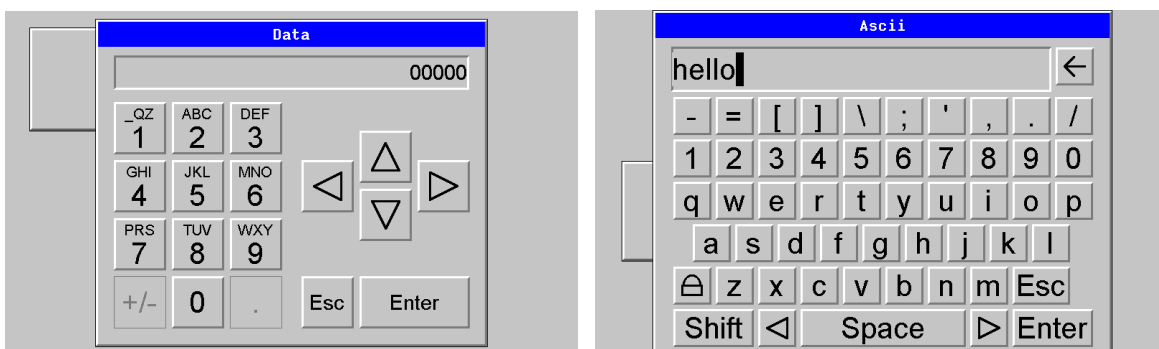

Figure 13.2 – Alpha-numeric Keypad and ASCII Keypad

Once the desired value is entered, pressing the *Enter* key moves that value into the object (and the corresponding OCS register) and the alpha-numeric keypad disappears. Alternately, pressing the *ESC* key any time before the *Enter* key cancels the operation, leaves the objects current value unchanged, and the alpha-numeric keypad disappears.

NOTE: Each numeric entry object has a configured minimum and maximum value. If the operator enters a value outside of the configured range, the new value is ignored when *Enter* is pressed and the current object value is NOT changed.

Since the alpha-numeric keypad services several different graphical objects, certain keys on the alpha-numeric keypad may be disabled (grayed) when the keypad is invoked for certain objects. The following describes the alpha-numeric keypad variation based on object.

Numeric Object	When editing a numeric value, the [+/-] or the [.] key are disabled (grayed) if the object is NOT configured for floating-point value or a signed value.
Password Object	When editing a password value, the arrow keys, [+/-], and the [.] keys are disabled. Additionally, overwrite mode is disabled. When entering digits, the pop-up keypad hides the value by displaying '*' alternately for each digit.
ASCII Object	When editing an ASCII value, an ASCII keypad is displayed as shown figure 13.2. The ASCII keypad has 3 modes, numeric, symbols and alpha. In Alpha mode the Caps Lock button may be pressed to access capital letters. When you first enter this editor typing a character will overwrite the entire old string and start a new entry. You may press the back space arrow to delete the previous character. Pressing Enter will save the entry, pressing ESC will cancel the edit and return the string to the previous value.
Text Table Object	When editing a Text Table Object, all the keys except the Up and Down arrow keys are grayed and disabled. The next text selection is made by pressing either the Up or Down arrow.
Time/Date Object	When editing a Time/Date Table Object, all the keys except the Up, Down, Left and Right arrow keys are grayed and disabled. The specific field (i.e. hour or minutes) is selected using the Left and Right arrows. The value in the selected field is changed by pressing either the Up or Down arrow.

13.4 Screen Navigation

To allow the operator to change screens, a **screen jump object** is generally used. This object may be visually **represented as a 3-D button** (responding to touch) or remain invisible and logically tied to an OCS register. An optional system ICON may be configured for display along with the legend, which aids in identifying the object as one that causes a screen change (shown below in figure 13.3)

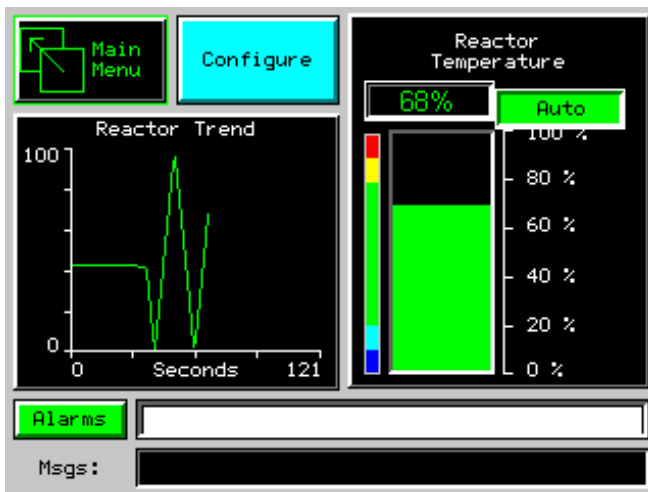

Figure 13.3 – Typical Screen Jump Object

Screen jumps can also be triggered on other keys or based on control logic for more advanced applications. To allow the operator to change screens, a **screen jump object** is generally used. This object may be visually **represented as a button** (responding to touch) or remain invisible and logically tied to an OCS register. An optional system ICON may be configured for display along with the legend, which aids in identifying the object as one that causes a screen change.

13.5 Ladder Based Screen Navigation

Ladder logic can use several techniques to control screen navigation. Coils can be tied to %D registers to make them screen coils. These coils have two modes, switch and alarm. If the ladder program energizes an alarm display coil, the screen associated with this coil is displayed and overrides the normal user

screens. This is designed to show alarm conditions or to display other ladder-detected events. When the text coil is de-energized, the previous screen that was being viewed before the alarm is returned.

The switch display coil switches to the associated screen when it is energized. Once it is de-energized the screen remains until it is switched by the user or ladder

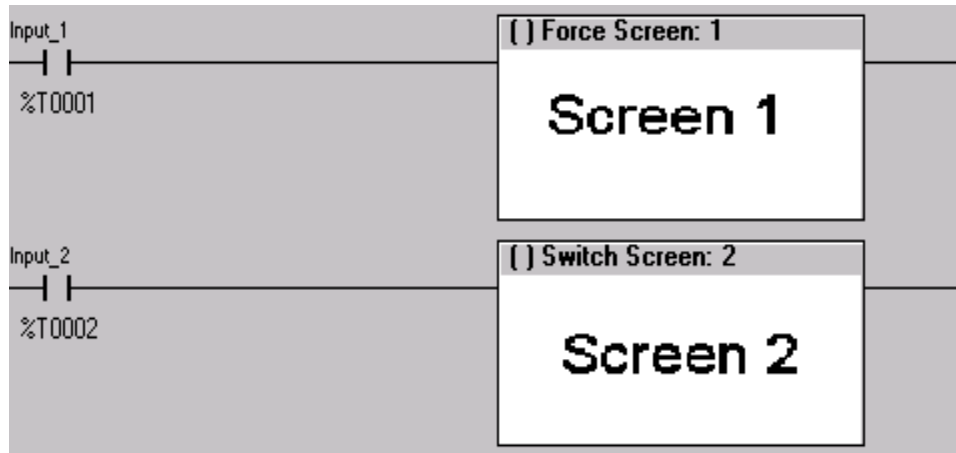

Figure 13.4 – Force and Switch Coils in Ladder Programming

There is also a system register that can be used to for control based screen navigation. %SR1 can be read to determine the current screen or written to change the current screen.

Refer to the on-line help in Cscape for more information on control-based screen navigation.

13.6 Beeper Acknowledgement

The eXL10 contains an internal beeper that provides an audible acknowledgment when an operator touches a graphic object that accepts touch input. When the graphic object is enabled, a short 5ms tone is emitted. When the graphic object is disabled, a longer 100ms tone is emitted to enounce that graphical object is not currently accepting the touch input.

If beep acknowledgement is not desired, the beeper function can be disabled from the system menu.

13.7 Touch (Slip) Sensitivity

Touch *slip* sensitivity is preset to meet most applications; however, adjustment is available to reduce the sensitivity for touch release. That is, once a graphical object (button) is touched and held by a finger, the default touch *slip* sensitivity allows for a slight *slip* of the finger on the graphical object before the eXL10 assumes touch has been released (equates to approximately a quarter inch of movement with a stylus).

In some applications (such as jog buttons) where the operator is pushing a button for a period of time, the amount of *slip* while holding a button pressed may exceed the default sensitivity. To increase the amount of tolerable *slip* and prevent false releases of the button, the eXL10 allows adjustment of the allowable *slide* up to 5x the default value.

To enable the touch (slip) sensitivity, first an OCS data register must be allocated through the Graphics editor Configuration menu for Display Settings. Once a Touch Sensitivity register is assigned, that register may be modified [range = 1(Low) to 5 (High)] to the desired slide amount. If a value outside the valid range is entered in the touch sensitivity register, it is ignored and the last valid value is used.

13.8 Alarms

Alarm presentation to the operator is highly configurable and beyond the scope of this document to describe fully. For more information refer to the graphics editor help file. This section presents a typical configuration thereby providing an introductory description on what the operator should expect.

The alarm object is generally used to enunciate alarms to the operator. While the display characteristics of this object is configurable, it is generally displayed as a button that changes colors to indicate the highest state of the alarm(s) in the alarm group it is monitoring. The following indicates the priority of the alarm states and the default colors associated with these states.

Highest	(Red)	Unacknowledged Alarms Exist
—	(Yellow)	Acknowledged Alarms Exist
Lowest	(Green)	No Alarms Exist

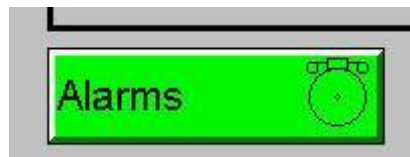

Figure 13.5 – Alarm Object

To view, acknowledge and/or clear alarms, the operator must access the alarm viewer. This is accomplished by touching an (enabled) alarm object. When accessed, the alarm viewer is displayed as pop-up alarm viewer dialog similar to that shown in Figure 13.6.

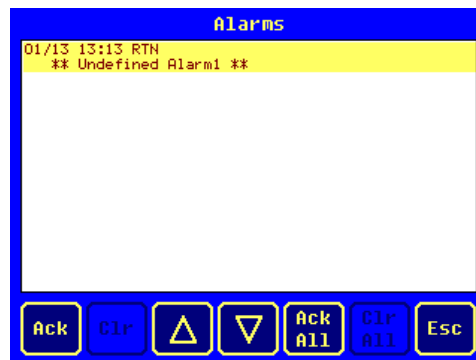

Figure 13.6 – Alarm Viewer

The currently selected entry is indicated by a yellow highlight which can be moved up or down by touching the arrow buttons or by directly touching an entry. If more entries exist than can fit on the page, a scroll bar is displayed on the right side that also indicates the current relative position.

The current state of the displayed alarm is indicated by its color and optionally by an abbreviated indicator after the date/time stamp (ALM, ACK, RTN). The operator can acknowledge an alarm by selecting it from the list and touching the ACK button. The operator can also clear an alarm if that function is enabled in the alarm object. If not enabled, the Clear buttons are grayed and do not respond

to touch. Once view operations are complete, simply touch the *Esc* button to remove the pop-up alarm viewer.

Note that OCS registers %SR181 and %SR182 are available for ladder use, which indicate presence of unacknowledged or acknowledged alarm (respectively). The screen designer may implement these registers to switch screens or activate the beeper to attract the operator’s attention.

13.9 Removable Media

The removable media object is generally used to inform the operator on the current state of the removable media device and allow access to its file structure. The removable media object is displayed as a button that changes colors to indicate the current state of the removable media device. The following indicates the device states and the default colors associated with these states.

Highest	(Red)	Device Error
—	(Yellow)	Device Full (threshold adjustable)
Lowest	(Green)	Device OK

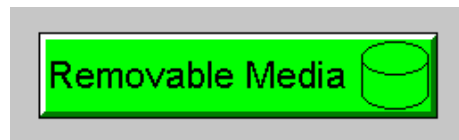

Figure 13.7 – Removable Media Object

To view and perform file operations, the operator must access the removable viewer. This is accomplished by either touching an (enabled) removable media object or through the system menu. When accessed, the removable media viewer is displayed as pop-up removable media dialog similar to that shown in Figure 13.8.

Note that the removable media object can be configured to open the removable media viewer at a certain directory complete with restrictions on transversing back up the file path. This may be used to restrict operator access to non-critical files.

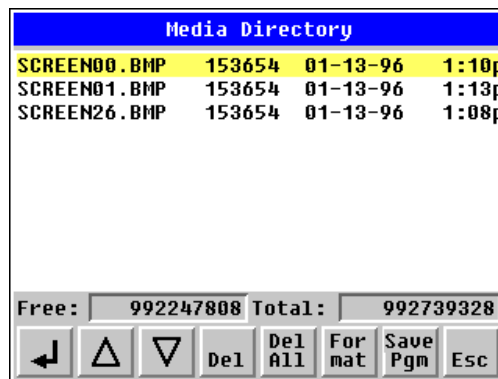

Figure 13.8 – Removable media viewer

The currently selected entry is indicated by a yellow highlight which can be moved up or down by touching the arrow buttons or by directly touching an entry. If more entries exist than can fit on the page, a scroll bar is displayed on the right side that also indicates the current relative position.

File operations are accomplished by pressing the appropriate button at the bottom of the removable media viewer. The configuration of the removable media object that invokes the removable media viewer defines what buttons are enabled and available to the user. A button is grayed and does not respond to touch if configured as disabled.

The ↵ (Enter) button (if enabled) performs certain operations based on the selected file's type:

..	change display to parent directory
<DIR>	change display to child directory
bmp, jpeg	display bitmap (if compatible format)
pgm	load application (if compatible model and version)

Alternately, the (enter) button can be configured to simply load the ASCII representation of the file path (including the file name) to a group of OCS registers. That pathname can then be used by ladder for opening and manipulating that file.

Once view operations are complete, simply touch the *Esc* button to remove the pop-up removable media viewer.

If the removable media is used in an application, the removable media device requires changing by the operator, and the application is attempting to write to the removable media when it is removed, the screen designer should create objects that allow the operator to temporarily halt access to the removable media. This prevents corruption to the file system if the removable media is removed during a file write sequence. The graphic objects should set OCS register %SR174.1 (when requesting the card be removed) and provide an indicator based on OCS register %SR174.2 (which indicates that it is safe to remove the removable media).

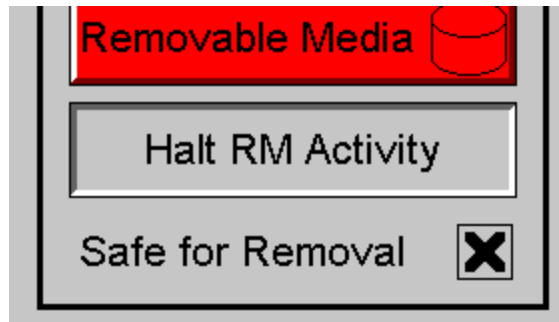

Figure 13.9 – Example application segment for safe removal of removable media

13.10 Screen Saver

The eXL10 screen backlight life is typically 5 years when in continuous use. If the application does not require interaction with the eXL10 for long periods of time, the backlight life can be extended by using the screen saver function. When enabled through the system menu, the backlight is shut off (screen goes black) after a specified time of no touch activity on the screen. When the screen saver shuts off the backlight, any operator touch on the screen or function keys reactivates the backlight. Note that when the screen saver is active (backlight shut off), any initial touch activity on the screen (or function key) to reactivate the backlight is otherwise ignored by the eXL10. Any additional touch activity is also ignored by the eXL10 for approximately one second thereafter.

It is possible for the application to temporarily disable the screen saver by generating a positive transition to %SR57.16 (coil only) at a rate faster than the screen saver timeout value. This may be desired while waiting for alarm acknowledgement.

13.11 Screen Brightness

The eXL10 provides a feature that allows screen dimming for night operation. To enable this feature, the application must access and control system register %SR57 (Display Backlight Brightness). Screen brightness is continuously variable by driving %SR57 through the range of 100 (full bright) to 0 (full off). It is left to the screen designer on how to present a Screen Brightness control to the user, if required.

NOTE: the backlight life may be shorted when screen is dimmed or screen brightness is varied on a repetitive basis.

CHAPTER 14: REGISTERS

14.1 Register Definitions

When programming the eXL10 OCS, data is stored in memory that is segmented into different types. This memory in the controller is referred to as registers. Different groups of registers are defined as either bits or words (16 bits). Multiple registers can usually be used to handle larger storage requirements. For example 16 single bit registers can be used to store a Word or two 16 bit registers can be used to store a 32-bit value.

Table 14.1 - Types of Registers found in the EXL10 OCS	
%AI Analog Input	16-bit input registers used to gather analog input data such as voltages, temperatures, and speed settings coming from an attached device
%AQ Analog Output	16-bit output registers used to send analog information such a voltages, levels or speed settings to an attached device
%D Display Bit	These are digital flags used to control the displaying of screens on a unit which has the ability to display a screen. If the bit is SET, the screen is displayed
%I Digital Input	Single-bit input registers. Typically, an external switch is connected to the registers
%K Key Bit	Single-bit flags used to give the programmer direct access to any front panel keys appearing on a unit
%M Retentive Bit	Retentive single-bit registers
%Q Digital Output	Single-bit output registers. Typically, these bits are connected to an actuator, indicator light or other physical outputs
%R General Purpose Register	Retentive 16-bit registers
%S System Bit	Single-bit bit coils predefined for system use
%SR System Register	16-bit registers predefined for system use
%T Temporary Bit	Non-retentive single-bit registers

14.2 Useful %S and %SR registers

Table 14.2 – Common %S Register Definitions	
Register	Description
%S1	Indicate First Scan
%S2	Network is OK
%S3	10mS timebase
%S4	100mS timebase
%S5	1 second timebase
%S6	I/O is OK
%S7	Always ON
%S8	Always OFF
%S9	Pause 'n Load soon
%S10	Pause 'n load done
%S11	I/O being forced
%S12	Forcing is enabled
%S13	Network I/O is OK
%S16	Ethernet COM module is OK

Table 14.3 – %SR Registers				
Register	Name	Description	Min Val	Max Val
%SR1	USER_SCR	Current User Screen Number	1	1023
%SR2	ALRM_SCR	Current Alarm Screen Number (0=none)	0	1023
%SR3	SYS_SCR	Current System Screen Number (0=none)	0	14
%SR4	SELF_TEST	Bit-Mapped Self-Test Result	0	65535

Table 14.3 – %SR Registers				
Register	Name	Description	Min Val	Max Val
%SR5	CS_MODE	Control Station Mode (0=Idle, 1=Do I/O, 2=Run)	0	2
%SR6	SCAN_RATE	Average Scan Rate (/ 10)	-	1000
%SR7	MIN_RATE	Minimum Scan Rate (/ 10)	-	1000
%SR8	MAX_RATE	Maximum Scan Rate (/ 10)	-	1000
%SR9-10	EDIT_BUF	Data Field Edit Buffer	0	2 ³² -1
%SR11-12	LADDER_SIZE	Ladder Code Size	2	256K
%SR 13-16	Reserved	-	-	-
%SR17-18	IO_SIZE	I/O Configuration Table Size	16	127K
%SR19-20	NET_SIZE	Network Configuration Table Size	34	1K
%SR21-22	SD_SIZE	Security Data Table Size	-	-
%SR23	LADDER_CRC	Ladder Code CRC	0	65535
%SR 24-25	Reserved	-	-	-
%SR26	IO_CRC	I/O Configuration Table CRC	0	65535
%SR27	NET_CRC	Network Configuration Table CRC	0	65535
%SR28	SD_CRC	Security Data Table CRC	0	65535
%SR29	NET_ID	This Station's Primary Network ID (CsCAN)	1	253
%SR30	NET_BAUD	Network Baud Rate (CsCAN) (0=125KB; 1=250KB; 2=500KB; 3=1MB)	0	3
%SR31	NET_MODE	Network Mode (0=network <u>not</u> required; 1=network required; 2=network optimized; 3=network required and optimized)	0	3
%SR32	LCD_CONT	LCD Display Contrast setting	0	255
%SR33	FKEY_MODE	Function Key Mode (0=Momentary; 1=Toggle)	0	1
%SR34	SERIAL_PROT	RS232 Serial Protocol Mode (0=Firmware Update (RISM); 1=CsCAN; 2=Generic (Ladder- Controlled); 3=Modbus RTU; 4=Modbus ASCII)	0	4
%SR35-36	SERIAL_NUM	This Station's 32-bit Serial Number	0	2 ³² -1
%SR37	MODEL_NUM	This Station's Binary Model Number	0	65535
%SR38	ENG_REV	Firmware Rev Number (/ 100)	0000	9999
%SR39	CPLD_REV	BIOS Rev Number (/ 100)	000	255
%SR40	FPGA_REV	FPGA Image Rev Number (/ 10)	000	255
%SR41	LCD_COLS	Vertical Pixel Count		
%SR42	LCD_ROWS	Horizontal Pixel Count		
%SR43	KEY_TYPE	Keypad Type		
%SR44	RTC_SEC	Real-Time-Clock Second	0	59
%SR45	RTC_MIN	Real-Time-Clock Minute	0	59
%SR46	RTC_HOUR	Real-Time-Clock Hour	0	23
%SR47	RTC_DATE	Real-Time-Clock Date	1	31
%SR48	RTC_MON	Real-Time-Clock Month	1	12
%SR49	RTC_YEAR	Real-Time-Clock Year	1996	2095
%SR50	RTC_DAY	Real-Time-Clock Day (1=Sunday)	1	7
%SR51	NET_CNT	Network Error Count	0	65535
%SR52	WDOG_CNT	Watchdog-Tripped Error Count	0	65535
%SR53-54	BAD_LADDER	Bad Ladder Code Error Index	0	65534
%SR55	F_SELF_TEST	Filtered Bit-Mapped Self-Test Result	0	65535
%SR56	LAST_KEY	Key Code of Last Key Press or Release	0	255
%SR57	BAK_LITE	LCD Backlight Dimmer Register 0 = 0% On; 25=25% On; 100-255 = 100% On	0	255
%SR58	USER_LEDS	User LED Control / Status	0	65535
%SR59-60	Reserved	-	-	-
%SR61	NUM_IDS	This Station's Number of Network IDs	1	253
%SR62	NUM_IDS	This Station's Number of Network IDs	1	253

Table 14.3 – %SR Registers

Register	Name	Description	Min Val	Max Val
%SR63	SS_BASE	SmartStack I/O Base Selector	0	7
%SR64	SS_STATUS	SmartStack I/O Base Status	0	2
%SR65-76	SS_INFO_1	SmartStack I/O Module #1 Information Structure	-	-
%SR77-88	SS_INFO_2	SmartStack I/O Module #2 Information Structure	-	-
%SR89-100	SS_INFO_3	SmartStack I/O Module #3 Information Structure	-	-
%SR101-112	SS_INFO_4	SmartStack I/O Module #4 Information Structure	-	-
%SR113-114	GOBJ_SIZE	Graphics Object Table Size	8	256K
%SR115-116	GSTR_SIZE	Graphics String Table Size	8	128K
%SR117-118	GBMP_SIZE	Graphics Bitmap Table Size	4	256K
%SR119-120	GTXT_SIZE	Graphics Text Table Size	8	128K
%SR121-122	GFNT_SIZE	Graphics Font Table Size	8	256K
%SR123-124	PROT_SIZE	Protocol Table Size	16	64K
%SR125	GOBJ_CRC	Graphics Object Table CRC	0	65535
%SR126	GSTR_CRC	Graphics String Table CRC	0	65535
%SR127	GBMP_CRC	Graphics Bitmap Table CRC	0	65535
%SR128	GTXT_CRC	Graphics Text Table CRC	0	65535
%SR129	GFNT_CRC	Graphics Font Table CRC	0	65535
%SR130	PROT_CRC	Protocol Table CRC	0	65535
%SR131-163	Reserved	-	-	-
%SR164.3		Read bit indicating Auto Restore of Register Data has been performed (Fail Safe)		
%SR164.4		Read bit indicating Backup of Register Data has been performed (Fail Safe)		
%SR164.5		Enable AUTORUN (Fail Safe)		
%SR164.6		Enable AUTOLOAD (Fail Safe)		
%SR164.7		Backup trigger bit		
%SR164.8		Clear Backup trigger bit		
%SR164.9		MAKE_CLONE trigger bit		
%SR164.10		LOAD_CLONE trigger bit		
%SR164.11		Status indicating Make Clone Fail (This bit goes high when Make / Create clone fails)		
%SR164.12		Status indicating Load Clone Fail (This bit goes high when Load clone fails)		
%SR165-174	Reserved			
%SR175	Removable Media	Current Removable Media interface status	0	6
%SR176-177	Removable Media	Indicates free space on the Removable Media card in K bytes.	0	2 ³¹
%SR178-179	Removable Media	Indicates the total card capacity in K bytes.	0	2 ³¹
%SR180	Reserved	-	-	-
%SR181	ALM_UNACK	Unacknowledged Alarm (high bit indicates what group #)		
%SR182	ALM_ACT	Active Alarm (high bit indicates what group #)		
%SR183	SYS_BEEP	System Beep Enable (0=disabled; 1=enabled)		
%SR184	USER_BEEP	Software configurable (0=OFF; 1=ON)		
%SR185	SCR_SAVER	Screen Saver Enabled (0=disabled; 1=enabled)		
%SR186	SCR_SA_TM	Screen Saver Time in minutes (delay)		
%SR187	NET_USE	Average Net Usage of all units on the CAN network		
%SR188	NET_MIN	Minimum Net Usage of all units on the CAN network		
%SR189	NET_MAX	Maximum Net Usage of all units on the CAN network		
%SR190	NT_TX_AVG	Average Net Usage of this unit		
%SR191	NT_TX_MIN	Minimum Net Usage of this unit		
%SR192	NT_TX_MAX	Maximum Net Usage of this unit		

For additional information on system bits and registers, refer to the on-line help found in Cscape.

14.3 Register Map for eXL10 OCS I/O

Table 14.4 – Register Map for EXL10 OCS I/O					
Fixed Address	Digital/Analog I/O Function	EXL10 Model			
		2	3	4	5
%I1	Digital Inputs	1-12	1-12	1-24	1-12
	Reserved	13-32	13-31	25-31	13-31
	ESCP Alarm	n/a	32	32	32
%Q1	Digital Outputs	1-6	1-12	1-16	1-12
	Reserved	7-24	13-24	17-24	13-24
%AI1	Analog Inputs	1-4	1-2	1-2	1-2
	Reserved	5-12	3-12	3-12	3-12
%AQ1	Reserved	n/a	1-8	1-8	1-8
	Analog Outputs	n/a	n/a	n/a	9-10

Reserved areas maintain backward compatibility with other XL Series OCS models

14.4 Resource Limits

Table 14.5– Resource Limits			
Resource	Value	Resource	Value
%S	16	Ethernet	CsCAN, Ping, EGD, SRTP, Modbus TCP Master (Downloadable protocol) & Slave, Ethernet IP, FTP, or HTTP @ 10 MBd or 100 MBd
%SR	448	CsCAN	125 kBd, 250 kBd, 500 kBd, or 1 MBd
%T	16000	Serial Ports	1 RS232, 1 RS485 Ports
%M	16000	IDs Per CsCAN Network	64 w/o repeat (253 w/ 3 repeaters)
%R	49999	Keypad	5 keys (4 fn keys and a System Key)
%K	5	Display	800 x 480 7" TFT, 65K colors
%D	1023	Screen Memory	64 MB
%I	2048	User Screens	1023
%Q	2048	Data Fields Per User Screen	1023
%AI	512	Ladder Code	1024 kB
%AQ	512		

NOTES

CHAPTER 15: CSCAPE CONFIGURATION

15.1 Overview

eXL10 OCS hardware is programmed with a Windows based PC application called Cscape. This application can be used to program, configure, monitor and debug all aspects of the eXL10 OCS unit. Please see the on-line help provided with Cscape for additional details.

15.2 Cscape Status Bar

When the eXL10 OCS is connected to a PC using Cscape software a Status Bar appears at the bottom of the screen. The Cscape Status Bar can be used to determine if communications have been established between the eXL10 OCS and the Cscape program. Components of the Cscape Status Bar are explained below.

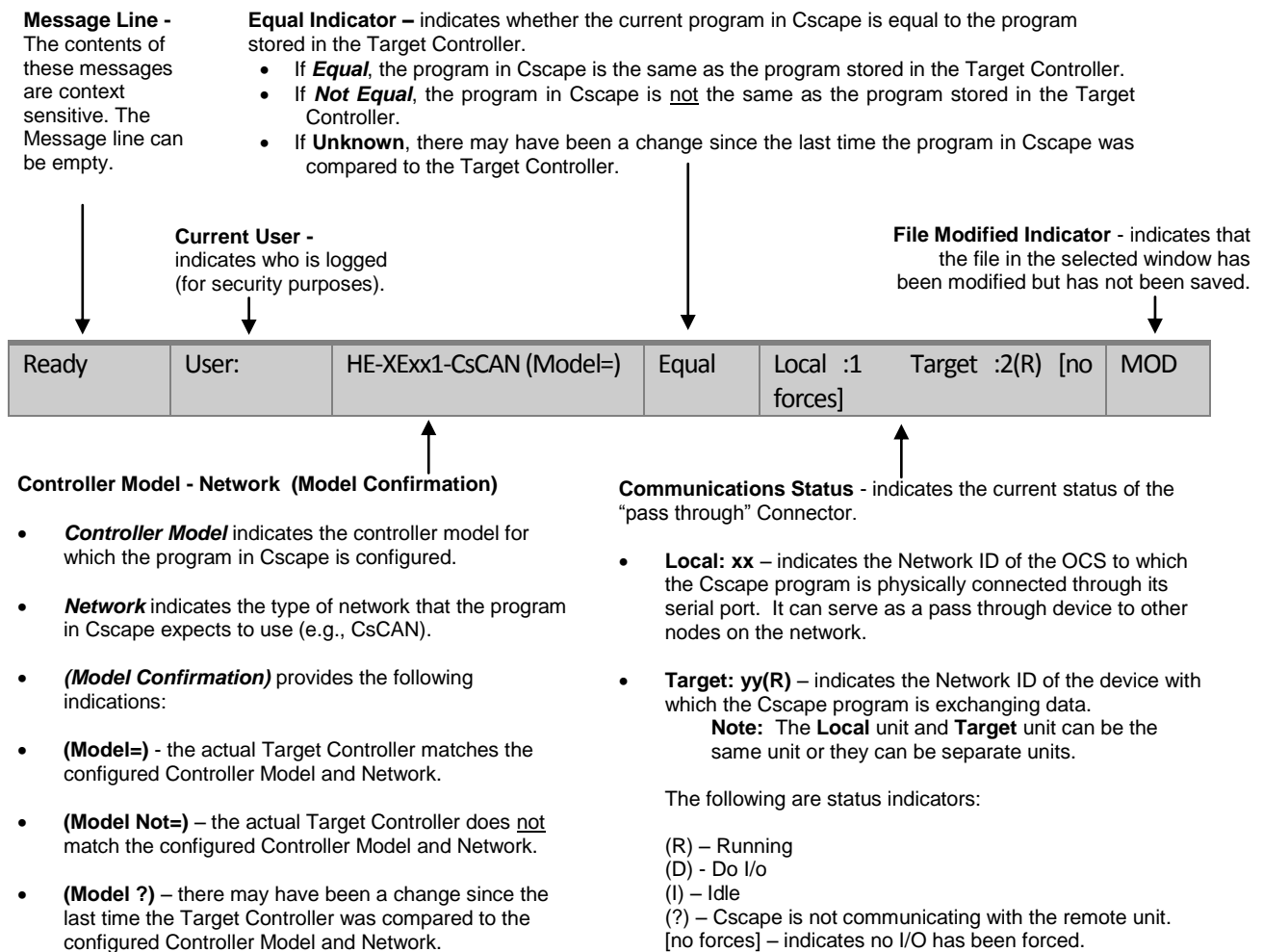

Figure 15.1 - Cscape Status Bar

15.3 Establishing Communications

The preferred method of communicating between Cscape and an eXL10 OCS is via USB port. The eXL10 OCS can communicate with Cscape using USB to USB, USB to serial adapters, serial port communications via MJ1 Port, Ethernet, CAN (CsCAN) or modems. For communications other than USB or the MJ1 port please refer to the manual which ships with the communications adapter hardware being used for programming.

To communicate with the eXL10 via USB you will need the automated driver installer located on the Horner APG web site.

For eXL10 use Cscape Ver 9.30 SP6 or newer.

Next, connect a PC's (Personal Computer running a Windows Microsoft operating system) USB port via USB cable to the USB mini B port on the eXL10 OCS.

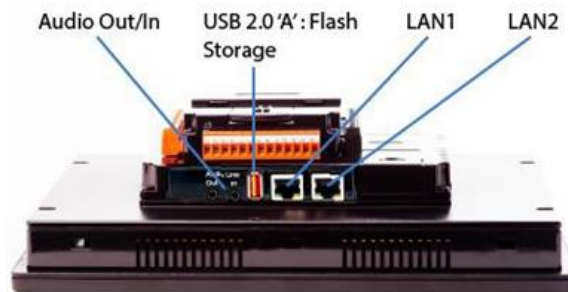

Figure 15.2 – USB Programming Connector

The PC will detect a new device has been plugged into the USB port.





Now that the eXL10 is plugged in, go to Cscape, Tools, Application Settings, Communications and choose the USB port (in this example Com 3).

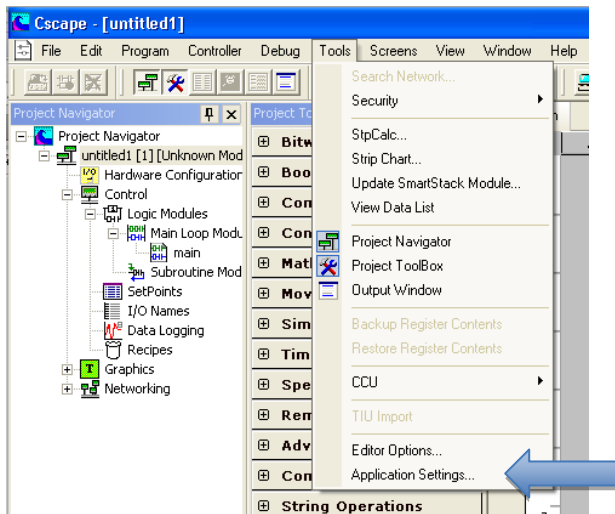

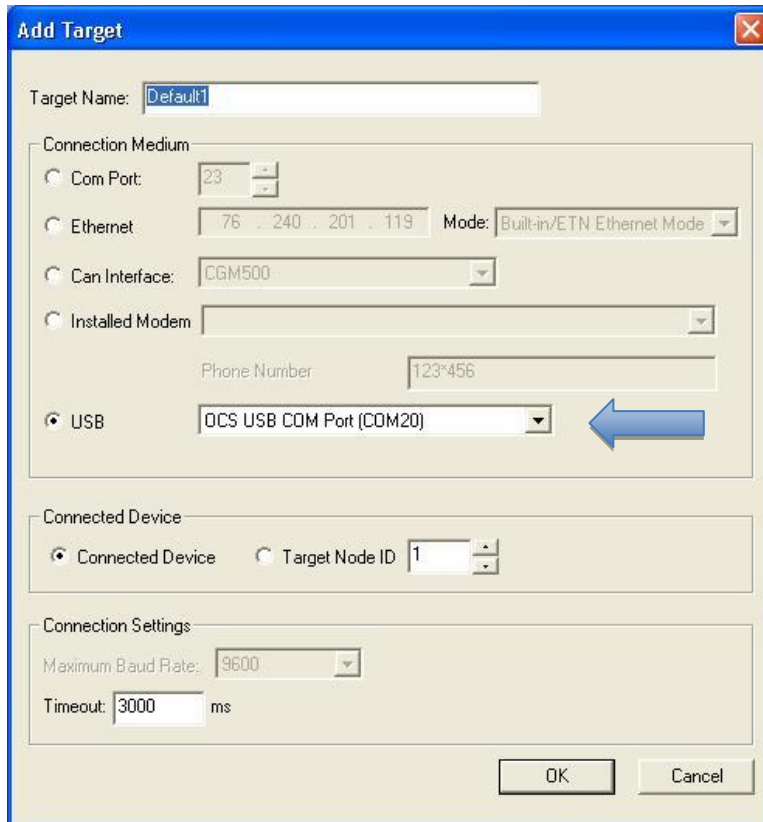

If communication is established, the target indicator will show the mode of the controller
Target: yy(R) as shown in the status section above in this chapter, section Cscape Status Bar.

If the controller is not communicating, ensure the target ID is set correctly. If not, set the target ID of the controller in Cscape or on the unit. The **Target ID** allows directing communications to a particular unit when multiple units are connected via a CsCAN network. Units without CsCAN network ports respond to any network ID and do not require the ID to be configured.

To check or change the ID on the eXL10 OCS, press the system menu key.



The first item in the menu is **Set Networks**. Pressing **Enter** allows the ID of the unit to be viewed or modified.



To change the Target ID of Cscape use the **Controller | Set Target Network ID** dialog.

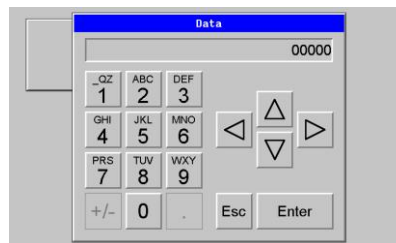

15.3.1 Communicating via MJ1 Serial Port

Start by configuring Cscape to use the correct communications port. This can be done using the Tools | Options | Communication Port dialog in Cscape.

Next, connect the PC's serial port to the port labeled MJ1 on the eXL10.

If communications are successful, the target indicator should show the mode of the controller Target: yy(R) as shown in the status section above.

If the controller is not communicating, it may be required to set the target ID of the controller in Cscape or on the unit. The Target ID allows directing communications to a particular unit when multiple units are connected via a CsCAN network. Units without CsCAN network ports respond to any network ID and do not require the ID to be configured.

To check or change the ID on the eXL10, press the System Button to enter the system menu. The first item in the menu is Set Network ID.

Pressing Enter allows the ID of the unit to be viewed or modified.

To change the Target ID of Cscape use the Controller | Set Target Network ID dialog.

15.3.2 Communicating via On Board Ethernet Port

From Cscape go to Controller -> I/O Configure and do auto configuration for the connected controller, Click on Config of Ethernet & go to Module Setup.

The IP address, Net Mask and Gateway of the controller may be temporarily set from the system menu under the Set Networks menu item. Once running or power cycled the configuration will come from the Cscape configuration stored in the unit.

In Module configuration dialog go to IP Address field enter unused IP Address and configure unused registers in Register field & then click OK. Screen shot for the same as follows:

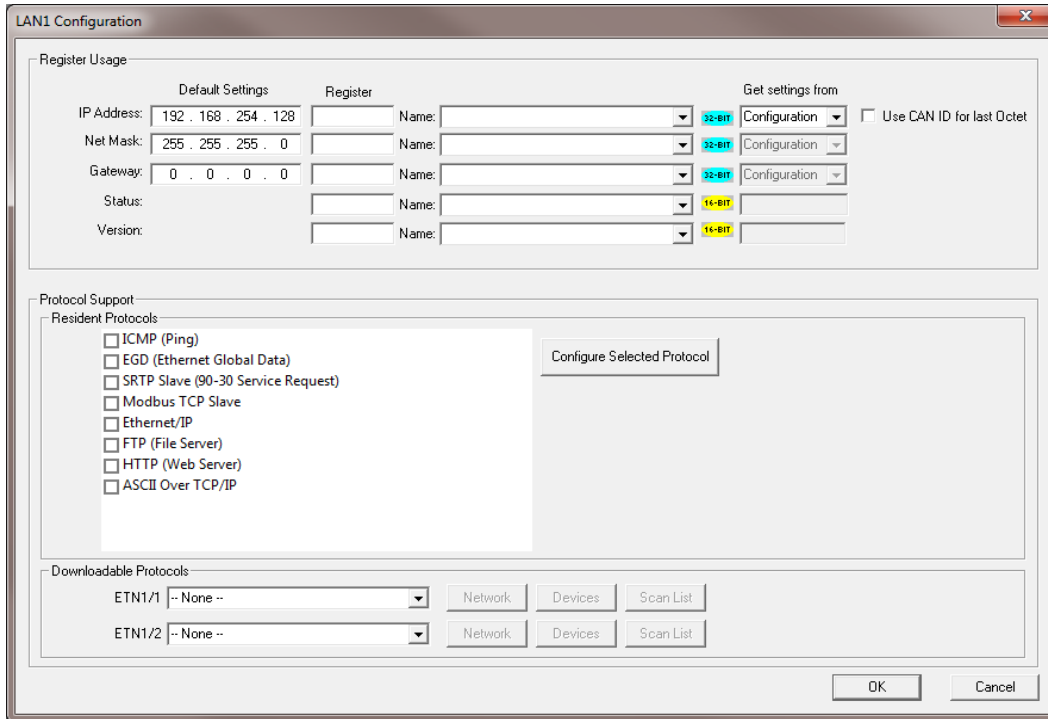

Download the configuration in to Controller. Connect LAN cable to the Controller in default LAN Port.

From Cscape go to Tools -> Editor Options -> Communication Port -> configure. Select Ethernet and enter IP address which is configured in the file. Select mode as XL Series mode from drop down list.

The controller should get connected to Cscape. If communications are successful, the target indicator should show the mode of the controller Target: yy(R) as shown in the status section above.

15.4 Configuration

An overview of configuration:

1. Start the configuration by selecting the **Controller | I/O Configure** menu item.
2. If the eXL10 OCS is connected to the PC press the **Auto Config System** button to automatically detect the Base model, I/O and any communication options.
3. If the eXL10 OCS is not connected press the **Config** button to the right of the top of the unit. This allows the base CPU to be selected.
4. Select either **eXL10 OCS Cscan** from the type drop down box.
5. Once the type of eXL10 OCS is selected, the model # drop down box will provide the eXL10 OCS model numbers from which to choose from.
6. Once the eXL10 OCS CPU is selected, press **OK** to exit the dialog and configure the I/O that is present in the first slot.
7. The I/O configure dialog (Specifically the **Module Setup** tab) provides 4 buttons to configure all of the I/O. Go through each area of I/O and configure it.
8. Once done configuring the I/O OK out of configuration dialogs.

Configuring the eXL10 OCS I/O has four main portions that are covered in this chapter. For additional information on I/O, refer the chapters covering General I/O or High Speed I/O in this manual.

The four areas of I/O configuration are:

- Digital in / HSC
- Digital out / PWM
- Analog in
- Analog out

15.5 Digital Input / HSC Configuration

The following figure illustrates the **Digital Input / HSC Configuration** dialog.

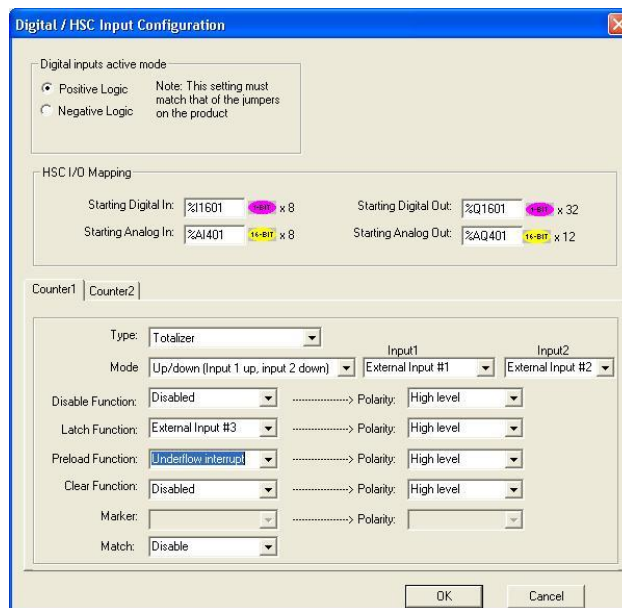

Figure 15.3 – Digital Input / HSC Configuration Dialog

The Active mode group box allows the user to select if inputs are active high (Positive logic) or active low (Negative logic). It is important that this setting match what the jumper settings are on the hardware.

The High Speed Counters group box contains all of the windows that are used for configuring the 4 available high speed counters on the eXL10 OCS. In configuring a counter, the user needs to set the type, mode, and counts per rev.

The type drop down includes the following options:

- Disabled
- Frequency Measurement
- Period Measurement
- Totalize
- Pulse Width Measurement
- Quadrature

For detailed descriptions of the High Speed Counter types available within the drop down menu, see Chapter 11, starting on page 45 of this manual.

15.6 Digital Output / PWM Configuration

The following figure illustrates the **Digital Output / PWM Configuration** dialog.

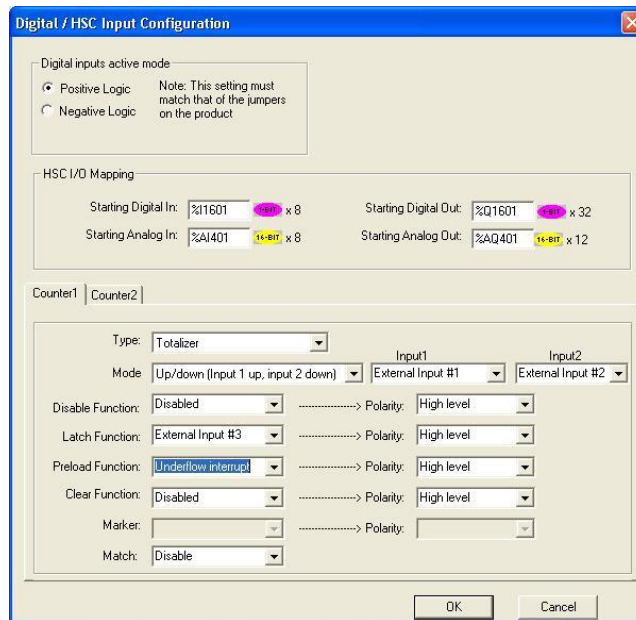

Figure 15.4 – Digital Output / PWM Configuration Dialog

The **Q1** and **Q2** group boxes allow the user to specify the operation of the multi-function outputs.

The **PWM State On Controller Stop** group box contains items that allow the user to specify how the PWM outputs behave when the controller is stopped. These items can either hold their value or default to some value when the controller is stopped.

Note that the PWM outputs are set to the OFF state at power-up and during program download and remain in that state until the unit is placed in RUN

The **Output State On Controller Stop** group box contains items to allow the user to specify how the remaining digital outputs behave when the controller is stopped. These items can either hold their value or default to some value when the controller is stopped.

15.7 Analog Input Configuration

The following figure illustrates the **Analog Input** Configuration dialog.

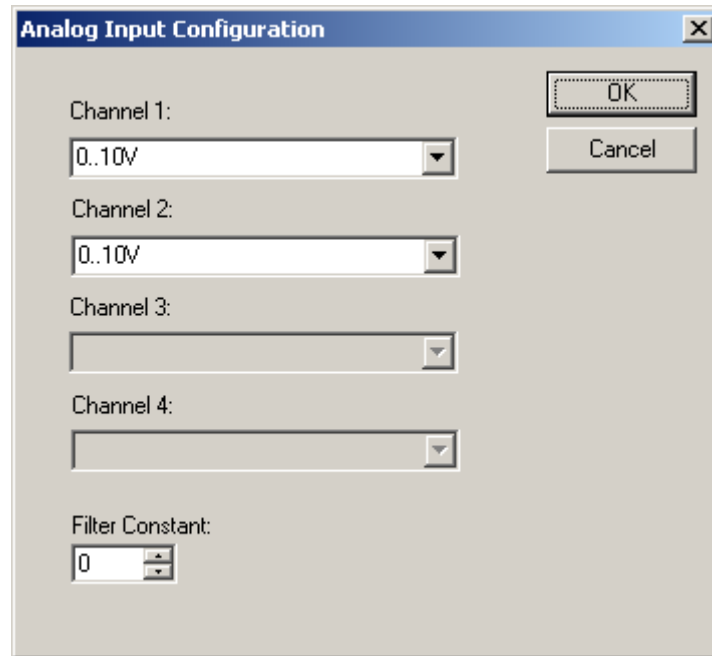

Figure 15.5 – Analog Input Configuration Dialog

The **Channel x** drop down windows allow the user to specify the mode for each analog input to operate. The **Channel x** drop down windows are enabled/disabled according to which model is being configured. All of the models have the following modes available:

- 0..10V
- 0..20mA
- 4..20mA

On model 005, all channels (1-4) also have the following modes available:

- 100mV
- PT100 DIN RTD, 1/20°c
- Type J Thermocouple, 1/20°c
- Type K Thermocouple, 1/20°c
- Type N Thermocouple, 1/20°c
- Type T Thermocouple, 1/20°c
- Type E Thermocouple, 1/20°c
- Type R Thermocouple, 1/20°c
- Type S Thermocouple, 1/20°c
- Type B Thermocouple, 1/20°c

The **Filter Constant** provides filtering to all channels.

15.8 Analog Output Configuration

The following figure illustrates the **Analog Output** Configuration dialog.

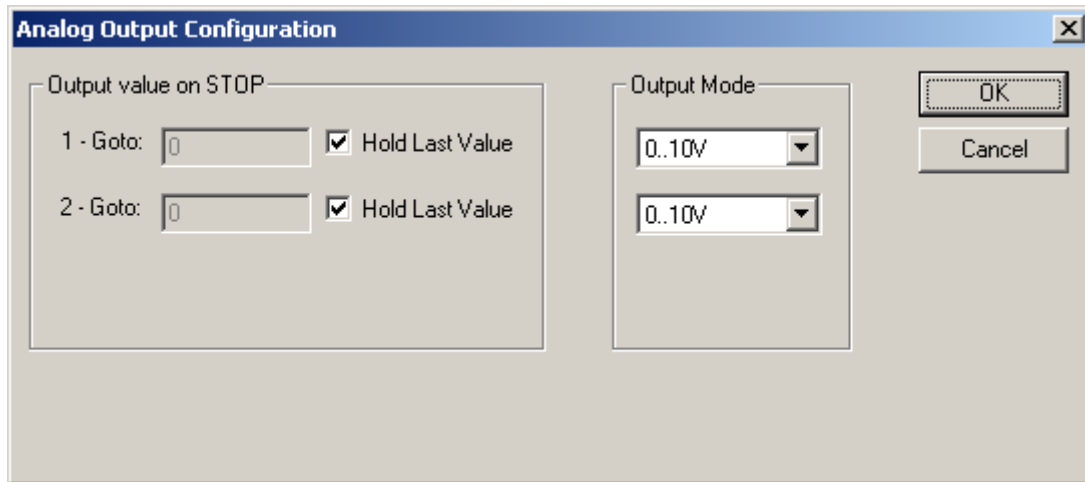

Figure 15.6 – Analog Output Configuration Dialog

The **Output value on Stop** group box contains items that allow the user to specify how the analog output channels behave when the controller is stopped. The outputs can either hold their value or default to a value when the controller is stopped.

The **Output Mode** group box allows the user to select the operating modes for each of the analog outputs. The modes include the following:

- 0..10V
- 0..20mA
- 4..20mA

Chapter 16: Fail – Safe System

16.1 Overview

The Fail-Safe System is a set of features that allow an application to continue running in the event of certain types of "soft" failures. These "soft" failures include:

- Battery power loss
- Battery-Backed Register RAM or Application Flash corruption due to, for example, an excessive EMI event.

The Fail-Safe System has the following capabilities:

- Manually backup the current Battery-Backed RAM Register Settings into Flash memory.
- Manually restore Register Settings from the values previously backed up in Flash to Battery-Backed RAM.
- Detect corrupted Register Settings at power-up and then automatically restore them from Flash.
- Detect corrupted or empty application in Flash memory at power-up and then automatically load the AUTOLOAD.PGM application file from Removable Media (Compact Flash or MicroSD).
- If an automatic Register Restore or Application Load occurs, the OCS can automatically be placed in RUN mode

The fail-safe system can be accessed by going to the system menu of the controller. A new menu "Fail-Safe System" has been added at the end of the main system menu for this. Selecting "Fail-Safe System" menu will open the following menu screen:

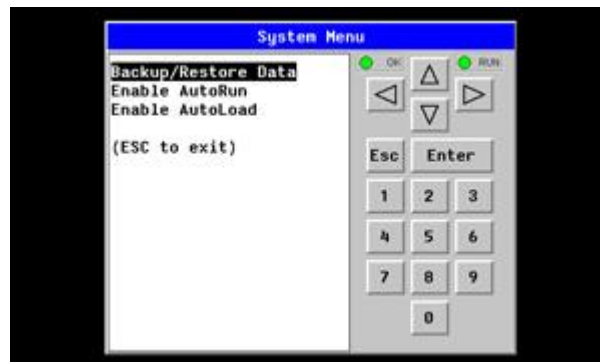

Figure 16.1 – Fail – Safe System Menu

16.2 Settings

To use the fail – safe feature, the user needs to do the following:

1. Backup the current Battery-Backed RAM Register contents in On-Board Flash memory using System Menu options.
2. From Cscope, create AUTOLOAD.PGM for the application program using 'Export to Removable Media'.
3. Place the Removable Media with AUTOLOAD.PGM in the device.
4. Set the 'Enable AutoLoad' option in the device to YES.

5. Set the 'Enable AutoRun' option to YES if the controller needs to be placed in RUN mode automatically after automatic restore of data or AutoLoad operation.

16.3 Backup / Restore Data

Selecting this option brings up a screen having four operations:

- Backup OCS Data.
- Restore OCS Data.
- Clear Backup Data.
- Exit



Figure 16.2 – Backup / Restore Data

Backup OCS Data:

When initiated, this will allow the user to manually copy Battery-Backed RAM contents on to the onboard FLASH memory of the OCS. This will have the effect of backing up all the registers and controller settings (Network ID, etc.) that would otherwise be lost due to a battery failure.

%SR164.4 is set to 1 when backup operation is performed.



Figure 16.3 – Backup Registers

Restore OCS Data:

When initiated, this will allow the user to manually copy the backed up data from the onboard FLASH to the Battery-Backed RAM.

A restore operation will be automatically initiated if a backup has been previously created and on power-up the Battery-Backed RAM registers fail their check.

The following process will be followed for restoring data:

- The controller will be placed in IDLE mode.
- Data will be copied from onboard FLASH to OCS Battery-Backed RAM
- The controller will reset.
- The controller will be put in RUN mode if the AutoRun setting is 'Yes' else it will remain in IDLE mode.



Figure 16.4 – Restore OCS Data

%SR164.3 is set to 1 only when an automatic restore operation is performed - not on a manual one. This bit is reset to 0 when a new backup is created.

Restoring of data can be manually performed by selecting RESTORE option from the Backup / Restore Data menu. This will cause the controller to reset.

Clear Backup Data:

When initiated, the backup data will be erased from the onboard Flash and no backup will exist.

%SR164.4 and %SR164.3 is reset to 0 when backed up data is erased.



Figure 16.5 – Clear Backup Data

Exit: Goes back to the previous screen.

The OCS follows the following sequence in execution of Automatic Restore:

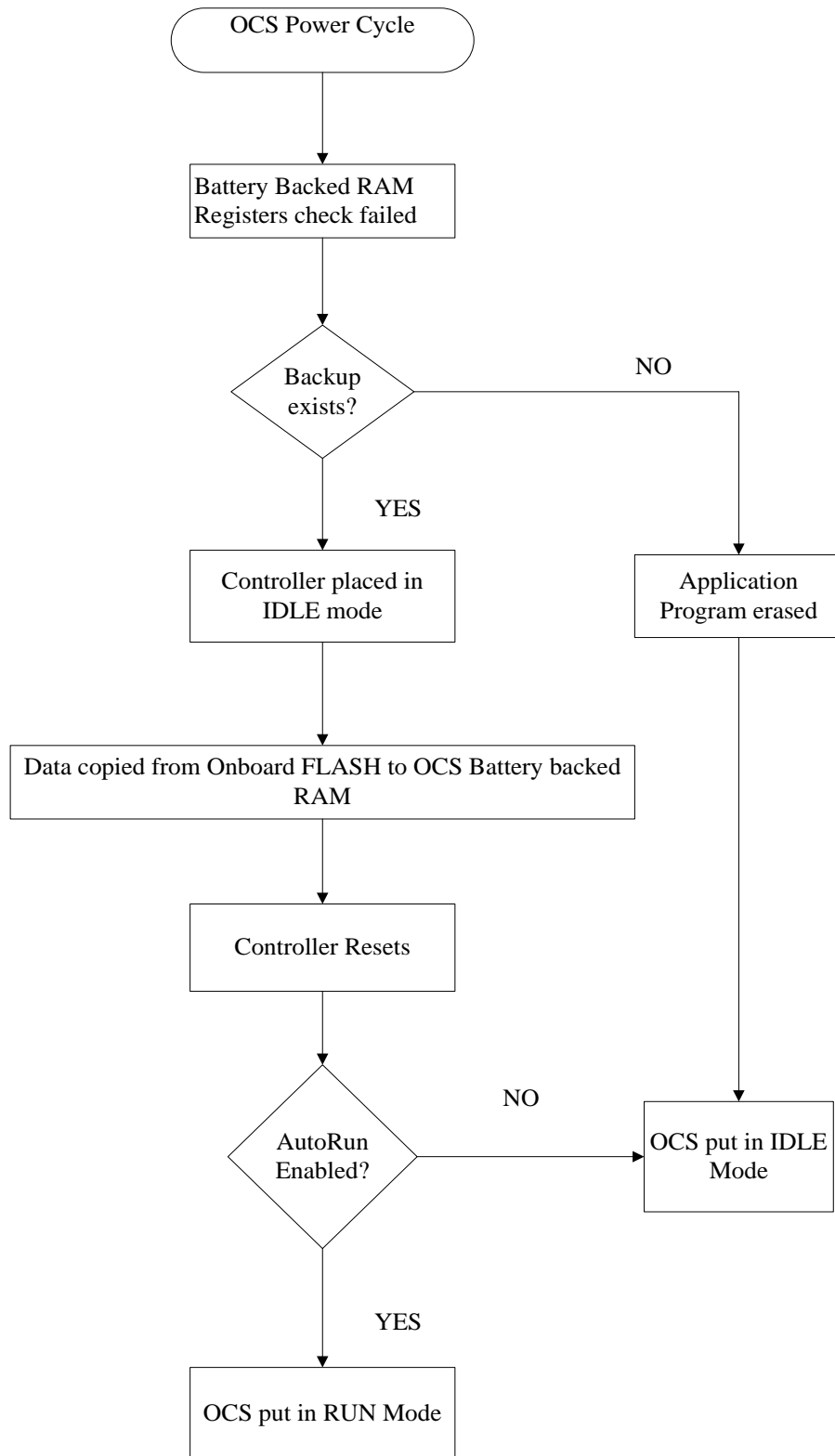

Figure 16.6 – Flow Chart for Automatic Restore

16.4 AutoLoad

This system menu option allows the user to specify whether the OCS automatically loads the application AUTOLOAD.PGM located in Removable Media.

When the AutoLoad setting is enabled (set to YES), it can either be manually initiated or automatically initiated at power-up.

The automatic initiation will happen only in the following two cases:

- When there is no application program in the OCS and a valid AUTOLOAD.PGM is available in the removable media of the device.
- When the program residing in onboard memory is corrupted and a valid AUTOLOAD.PGM is available in the removable media of the device.

AutoLoad can be manually initiated when the SYS-F3 key is pressed (OCS can be in any of the following mode – Idle / Run / DOIO). This also requires a valid AUTOLOAD.PGM to be present in the removable media of the device.

When the AutoLoad setting is not enabled (set to NO), OCS will be in IDLE mode and the application is not loaded.

If the AUTOLOAD.PGM is security enabled, the user will be prompted to enter the password before loading the application. The application will be loaded from the Removable media only after getting the correct password.

%SR164.6 can be set to enable AutoLoad feature.

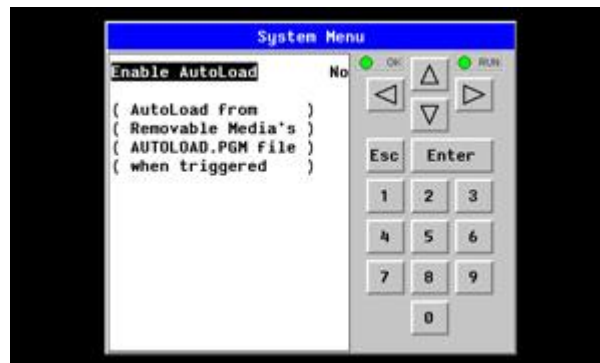

Figure 16.7 – AutoLoad Menu

The OCS follows the following sequence in execution of AutoLoad:

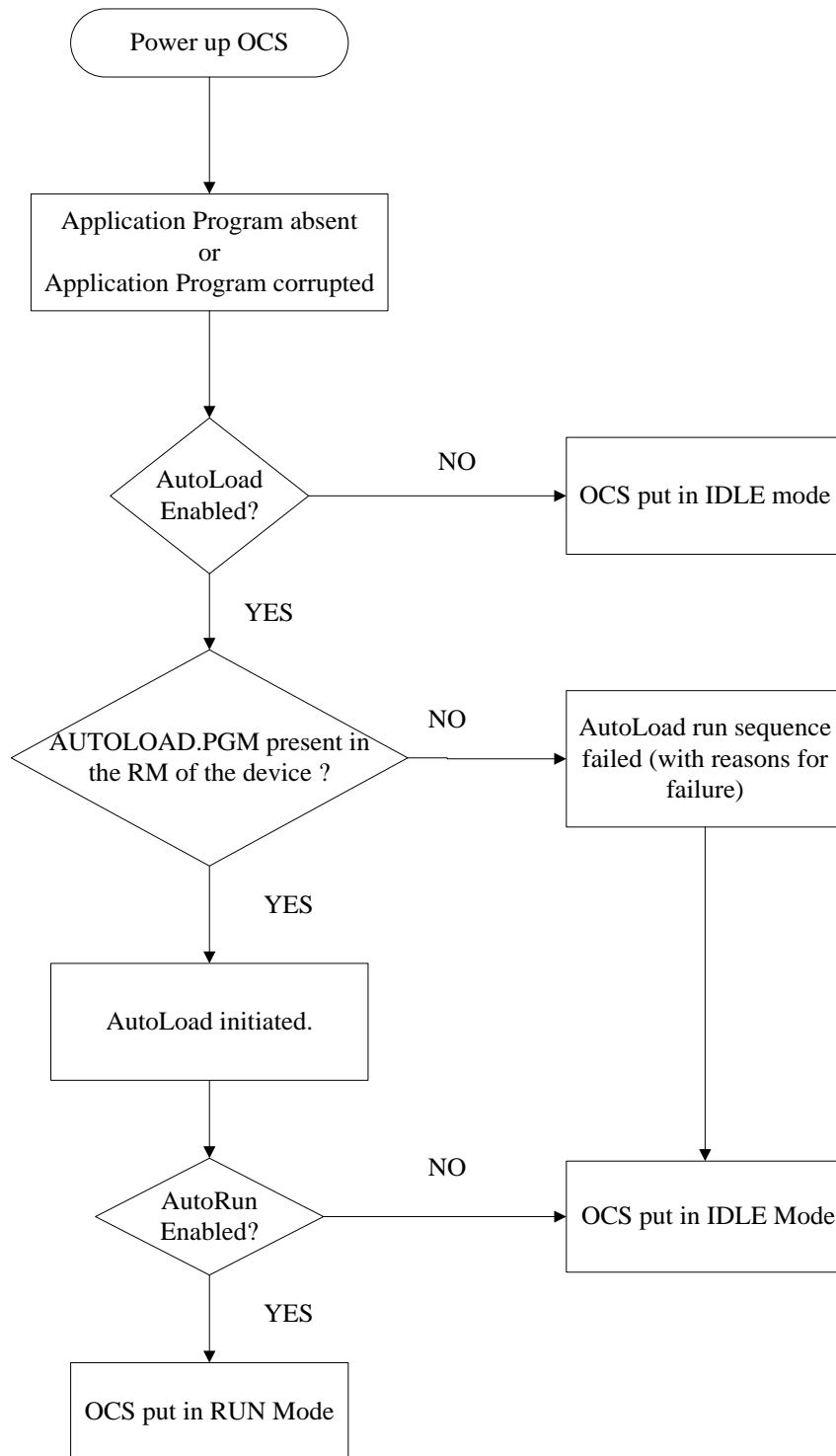

Figure 16.8 – Flow Chart for AutoLoad

16.5 AutoRun

This system menu option, when enabled (YES), allows the user to automatically place the OCS into RUN mode after the AutoLoad operation or automatic Restore Data operation.

When the AutoRun setting is disabled (NO), the OCS remains in the IDLE mode after a Restore Data or AutoLoad operation.

%SR164.5 can be set by putting the system into RUN mode automatically, once an AutoLoad has been performed or an Automatic Restore has occurred.

If for any reason the AutoLoad-Run (Loading the AUTOLOAD.PGM automatically and OCS put in RUN mode) sequence does not succeed, a pop-up message box saying "AUTO-LOAD-RUN SEQUENCE FAILED" will be displayed. It will also show the reason for its failure. On acknowledging this message box the AutoLoad-Run sequence will be terminated, controller will return to the first user-screen and will be placed in IDLE mode.



Figure 16.9 – AutoRun Menu

CHAPTER 17: CLONE UNIT

17.1 Overview

'Clone Unit' feature allows the user to "clone" the OCS of the exact same model. This feature "clones" application program and unit settings stored in Battery backed RAM of an OCS into the RM (refer Removable Media, Chapter 9, for details in using RM). It can then be used to clone a different OCS (exact same model).

This feature can be used for:

- Replacing an OCS by another unit of the same model.
- Duplicating or "clone" units without a PC.

17.2 Clone

User needs to perform the following to Clone:

1. The 'Clone Unit' can be accessed by going to the 'System Menu' of the OCS. A new menu "Clone Unit" has been added at the end of the main system menu as shown below:

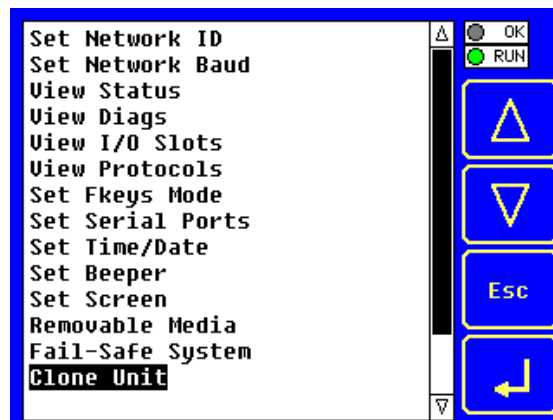

Figure 17.1 – System Menu

2. Selecting "Clone Unit" menu will open the following menu screen:

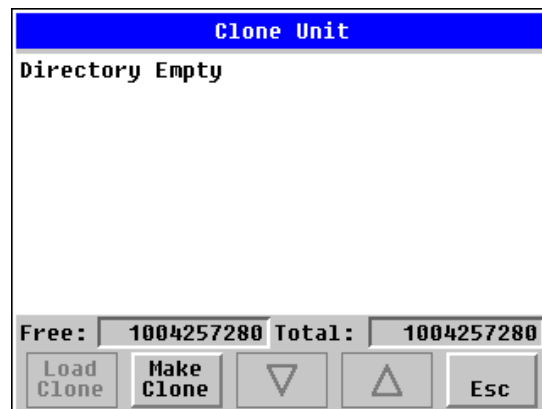

Figure 17.2 – Clone Unit Menu before Cloning

Free/Total – displays number of free and total bytes in Removable Media.

3. Make/Create Clone option enables user to duplicate / Clone application file, all unit settings and all register values from Battery Backed RAM.

Selecting Make Clone brings up the screen below for the user:

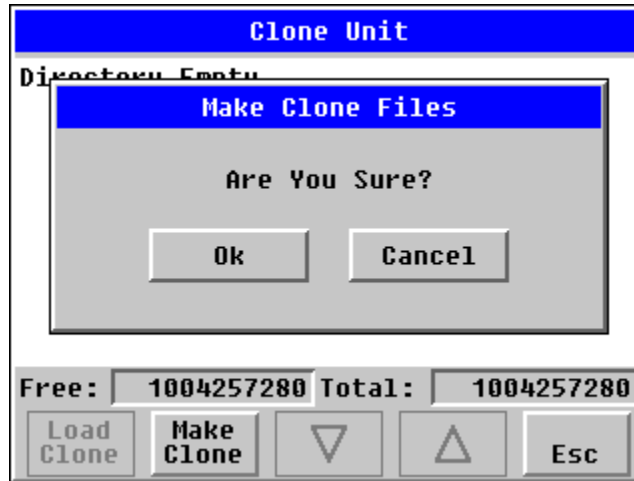

Figure 17.3 – Clone Unit Confirm Screen

After confirmation, the OCS will create two new files in the root directory of the Removable Media Drive as shown below:

AUTOLOAD.PGM	Application file
CLONE.DAT	File having all unit settings and register values from Battery Backed RAM

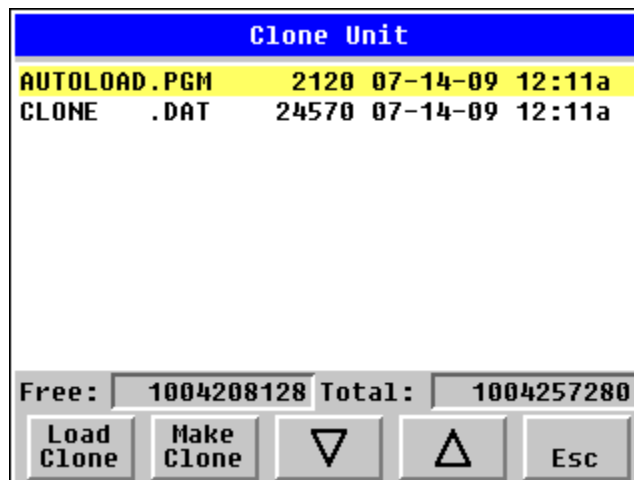

Figure 17.4 – Clone Unit Files

NOTE: Make/Create clone operation automatically includes the security in \AUTOLOAD.PGM file for security enabled files.

4. Once the cloning is successful, OCS gives a message as below:

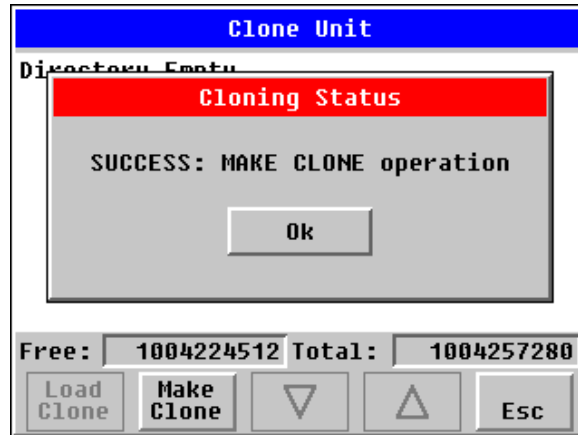

Figure 17.5 – Cloning Status

Make/Create clone can also be triggered by setting %SR164.9 bit to “1” from Ladder program or graphics. Once the operation is completed, this bit is made zero by the firmware. When Make clone operation is triggered by this SR bit, it does not ask the user for confirmation for making clone. The success / failure of the operation is also not notified on screen to the user.

In case of failure of “Make Clone” operation, %SR164.11 bit is set to “1” by the firmware and never reset.

NOTE: Backup of registers in flash memory is not performed by Clone Feature. If user desires, Backup should be done as explained in Chapter 16 (Fail Safe System).

17.3 Load Clone

This option loads the application, all unit settings and register values from Removable media to the Battery backed RAM (Regardless of AutoLoad settings) and then resets the OCS for the settings to take effect.

User needs to perform the following to Load Clone:

1. Select “Clone Unit” from main system menu of OCS as shown below:

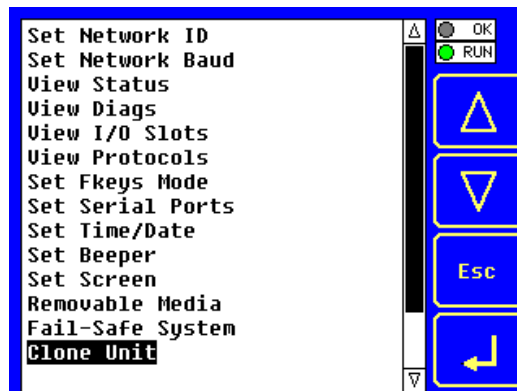

Figure 17.6 – System Menu

2. Selecting “Clone Unit” menu will open the following menu screen. Select “Load Clone”.

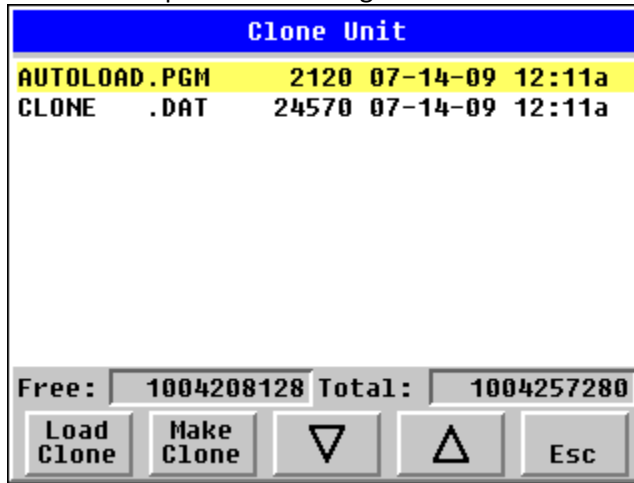

Figure 17.7 – Clone Unit Menu after Cloning

3. User needs to confirm Load Clone as shown below:

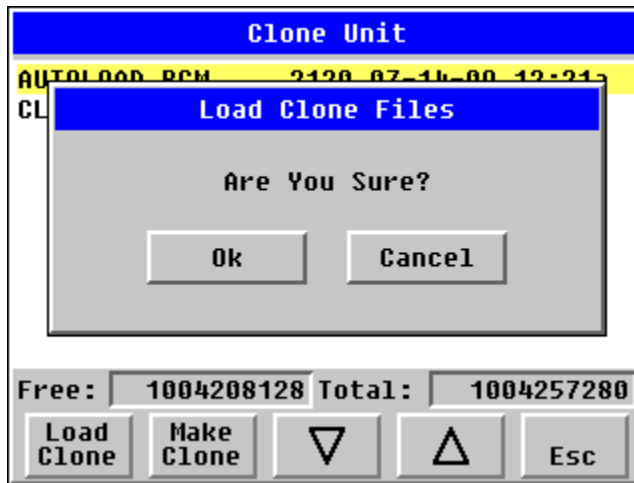

Figure 17.8 – Load Clone Confirm Screen

4. After confirmation, all unit settings and register values will be loaded from Removable media to the Battery backed RAM (Regardless of AutoLoad settings) and then OCS resets for the settings to take effect.

NOTE: For security enabled files, Load clone asks for password validation before loading the application.

Load clone can also be triggered by setting %SR164.10 bit to “1” from Ladder program or graphics. Once the operation is completed, this bit is made zero by the firmware. When Load clone operation is triggered by this SR bit, it does not ask the user for confirmation for loading clone. The success / failure of the operation is also not notified on screen to the user.

In case of failure of “Load Clone” operation, %SR164.12 bit is set to “1” by the firmware and never reset.

CHAPTER 18: MAINTENANCE

18.1 Firmware Updates

The eXL10 OCS products contain field updatable firmware to allow new features to be added to the product at a later time. Firmware updates should only be performed when a new feature or correction is required.

Warning: Firmware updates should only be performed when the equipment being controlled by the eXL10 OCS is in a safe, non-operational state. Communication or hardware failures during the firmware update process can cause the controller to behave erratically resulting in injury or equipment damage. Make sure the functions of the equipment work properly after a firmware update before returning the device to an operational mode.

Steps for updating the firmware:

1. Loading new firmware will erase any program stored in the OCS for safety and compatibility reasons. Please backup the application prior to performing a firmware update.
2. Copy the supplied files onto a FAT32 formatted MicroSD or USB based flash device.
3. Insert the flash device into the eXL10 making sure no other memory or drives are connected to the device.
4. Press and hold the system menu for at least 6 seconds and a firmware update menu will be presented.
5. If you are just updating the firmware, press the “Update Firmware” button. If you are updating the bootloader, firmware and FPGA, press the “Update Bootloader” button. On early versions of firmware this can take several minutes. This will take about 15 seconds on newer firmware.

18.2 Backup Battery

The eXL10 has an advanced battery system. It uses a rechargeable lithium battery. The battery powers the real time clock when power is removed. To store registers, the battery continues to power the OCS for less than a second after external power is removed. In this time the registers and other retentive data is saved to internal flash memory. This battery will need about 8 hours of charging to last approximately 2 years when powered off.

NOTE: For the registers to be retentive the battery only need to be charged and present at power down.

Under normal conditions the battery in the eXL10 OCS should last approximately seven years. Higher operating temperatures or variations in batteries may reduce this time.

18.2.1 Indications the battery needs replacing

The eXL10 OCS indicates the battery is low, failed or missing in a variety of ways. At power-up, an error message is displayed indicating the low or missing battery. The user program can monitor the battery using %SR55.13. This bit will turn on if the battery is low or missing. The system menu also contains a battery status message under the diagnostics sub-menu (see the chapter on System Settings and Adjustments).

18.2.2 Battery Replacement

Warning: Lithium Batteries may explode or catch fire if mistreated

Do not recharge, disassemble, heat above 100°C (212°F) incinerate, or puncture.

Warning: Disposal of lithium batteries must be done in accordance with federal, state, and local regulations. Be sure to consult with the appropriate regulatory agencies *before* disposing batteries. In addition, do not re-charge, disassemble, heat or incinerate lithium batteries.

Warning: Do not make substitutions for the battery.

Be sure to only use the authorized part number to replace the battery.

The eXL10 OCS uses a lithium ion battery available from Horner APG.

Below are the steps to replace the battery:

1. Make sure the user program and any data stored in retentive memory is backed up.
2. Disconnect all power from the eXL10 OCS unit including I/O power.
3. On the back of the eXL10 model, unscrew the battery plate cover using a Phillips head screwdriver.
4. Slide battery plate cover off the bottom of the unit.
5. Remove the old battery and replace with a new 14500 Li-ion battery (+ on left, – on right)
NOTE: Do not use an alkaline AA battery, only use the proper battery type listed above and on the unit battery plate cover.
6. Dispose of the old battery properly; see the above warning on disposal regulations.
7. Install the new battery
8. Slide battery plate cover back on the unit from the bottom up and re-tighten the screw in place.
9. Apply power to the unit. Check that the battery error is no longer reported. If the unit still reports the error, remove the battery immediately and contact Technical Support.

CHAPTER 19: TROUBLESHOOTING / TECHNICAL SUPPORT

Chapter 19 provides commonly requested **troubleshooting information and checklists** for the following topics.

- Connecting to the eXL10 OCS controller
- Local controller and local I/O
- CsCAN Network
- Removable media

In the event that this information is not enough, please contact Technical Support at the locations indicated at the end of this chapter.

19.1 Connecting to the eXL10 OCS

Cscape connects to the local controller automatically when the serial connection is made. The status bar below shows an example of a successful connection. This status bar is located in the bottom right hand corner of the Cscape window.

Local:253 Target:253(R) [no forces]

In general the **Target** number should match the **Local** number. The exception to this is when the controller is being used as a "pass through" unit where other controllers on a CsCAN network could be accessed through the local controller.

Determine connection status by examining feedback next to **Local & Target** in the status bar of Cscape.

Local: ###	If a number shows next to Local then communication is established to the local controller.
Local: No Port	Cscape is unable to access the COM port of the PC. This could mean that Cscape is configured for a COM port that is not present or that another program has control of the COM port. Only one Cscape window can access a port at a time. Subsequent instances of Cscape opened will indicate No Port.
Local: No Com	Cscape has accessed a PC COM port, but is not communicating with the controller. This typically occurs when the controller is not physically connected.
Local: ???	Unknown communication error. Close Cscape, power cycle the controller and reopen Cscape with a blank project. Check Local.
Target: #(I,R,D)	If I (idle), R (run), or D (do I/O) shows next to Target number then communication is established to the target controller.
Target: #(?)	Communication is not established to the target controller. Check node ID of controller and set Target to match. Make sure local connection is established.

Table 19.1 – Cscape Target & Local Numbers

19.1.1 Connecting Troubleshooting Checklist (serial port – MJ1 Programming)

1. Programming and debugging must use MJ1 or USB Mini B Port.
2. Controller must be powered up.
3. Ensure that the correct COM port is selected in Cscope. Tools/Editor Options/Communications Port.
4. Ensure that a straight through (non-null modem) serial cable is being used between PC and controller port MJ1.
5. Check that a Loaded Protocol or ladder is not actively using MJ1. Taking the controller out of run mode from the System Menu on the controller will make MJ1 available to Cscope.
6. Make sure the COM port of the PC is functioning. An RS232 serial loopback and Microsoft HyperTerminal can determine positively if the COM port is working. Or connect to an alternate device to determine if the port is working.
7. Successful communications with USB-to-serial adapters vary. If in doubt, Horner APG offers a USB to serial adapter. Part number HE500USB600.
8. eXL10 OCS units without Ethernet must use MJ1 or the Mini B USB Port for programming and debugging. If Ethernet is installed it can be selected as the programming port. The selection is made in the controller's System Menu. If there are difficulties connecting, make sure that the default programming port is set correctly with the connection method being attempted.

19.1.2 Connecting Troubleshooting Checklist (USB Port - Mini B Programming)

1. Programming and debugging must use Mini B USB Port or MJ1.
2. Controller must be powered up.
3. Ensure that the correct COM port is selected in Cscope: Tools/Editor Options/Communications Port
4. Be sure that the USB cable is connected between the PC and controller and check the Windows Device Manager to find out if the USB driver is properly installed and which port it set itself up on..
5. Make sure the USB port of the PC is functioning and/or connect to an alternate device to determine if the port is working.
6. eXL10 OCS units without Ethernet must use the Mini B USB Port or MJ1 for programming and debugging. If Ethernet is installed it can be selected as the programming port. The selection is made in the controller's System Menu. If there are difficulties connecting, make sure that the default programming port is set correctly with the connection method being attempted.

19.1.3 Connecting Troubleshooting Checklist (ETN port programming)

1. Programming and debugging must use MJ1 or Ethernet Port.
2. Controller must be powered up.
3. Ensure that correct IP address is given in the Ethernet field and correct Mode is selected, in Cscope: Tools/Editor Options/Communications Port
4. Ensure that the Ethernet Cable is connected between the controller and the Ethernet Hub.
5. Make sure the Ethernet cable is functioning properly.

19.2 Local Controller and Local I/O

The system menu provides the following status indications that are useful for troubleshooting and system maintenance.

- Self-test results, diagnostics.
- RUN and OK status
- Network status and usage

- Average logic scan rate
- Application memory usage
- Loaded firmware versions
- Loaded protocols
- Removable media access

To view the system menu, press the System key.



19.2.1 Local I/O Troubleshooting Checklist

1. Verify the controller is in RUN mode.
2. Check diagnostics to insure controller passed self-tests.
View diags in System Menu or in Cscape, click; Controller/Diagnostics
3. Check data sheets to insure proper wiring.
4. Insure that hardware jumpers and software configuration for I/O match.
5. Check data sheets for voltage and current limits.
6. Take ladder out of the picture. From Cscape set controller to “Do I/O” mode. In this mode inputs can be monitored and outputs set from a data watch window in Cscape without interference from the ladder program. Some I/O problems are only a result of a mistake in the ladder program.

WARNING: Setting outputs ON in Do I/O mode can result in injury or cause machinery to engage in an unsafe manner depending on the application and the environment.

19.3 CsCAN Network

For complete information on setting up a CsCAN network, refer to CAN Networks manual (MAN0799) by visiting the Horner websites for the address to obtain documentation and updates.

Network status, node ID, errors, and baud rate in the controller system menu are all in reference to the CsCAN network. These indications can provide performance feedback on the CsCAN network and can also be used to aid in troubleshooting.

19.3.1 CsCAN Network Troubleshooting Checklist

1. Use the proper Belden wire type or equivalent for the network as specified in MAN0799.
2. The eXL10 OCS does not provide 24VDC to the network. An external voltage source must be used for other devices such as SmartStix I/O.
3. Check voltage at both ends of the network to insure that voltage meets specifications of attached devices.
4. Proper termination is required. Use 121-ohm (or 120-ohm) resistors at each end of the network. The resistors should be placed across the CAN_HI and CAN_LO terminals.
5. Measure the resistance between CAN_HI and CAN_LO. If the network is properly wired and terminated there should be around 60 ohms.
6. Check for duplicate node ID's.
7. Keep proper wires together. One twisted pair is for V+ and V- and the other twisted pair is used for CAN_HI and CAN_LO.
8. Make sure the baud rate is the same for all controllers on the network.
9. Assure shields are connected at one end of each segment -- they are not continuous through the network.
10. Do not exceed the maximum length determined by the baud rate and cable type.

11. Total drop length for each drop should not exceed 6m (20 feet). A drop may include more than one node. The drop length adds to the overall network length.
12. Network should be wired in "straight line" fashion, not in a "star" pattern.
13. In applications requiring multiple power supplies, make sure the V- of all supplies is connected together and to earth ground at one place only.
14. In some electrically noisy environments it may be necessary to add repeaters to the network. Repeaters can be used to add additional nodes and/or distance to the network and protect the signal against noisy environments. The Horner APG repeater is part # HE200CGM100.\

19.4 Removable Media - Basic Troubleshooting

Description	Action
eXL10 OCS does not read media card.	The media card should be formatted with the eXL10 OCS.
eXL10 OCS will not download project file.	Make sure the project file is saved as a .pgm file and not a .csp file. In addition, to file must be .pgm, the file's I/O configuration must match the eXL10 configuration for it to download.

Table 19.2 – Removable Media Troubleshooting

19.5 Technical Support Contacts

For manual updates and assistance, contact Technical Support at the following locations:

North America:

Tel: (317) 916-4274

Fax: (317) 639-4279

www.heapg.com

Email: techspt@heapg.com

Europe:

Tel: (+) 353-21-4321-266

Fax: (+353)-21-4321826

www.horner-apg.com

Email: tech.support@hornerapg.com

Main Index

- %Q bits, 40
- %S & %SR, 74
- Accessories, 15
- Accumulator, 44-46
- Alarms, 69
- Alpha-numeric keypad, 66
- Analog Inputs, 42
- Analog Input Tranzorb Failure, 43
- Analog Outputs, 43
- AutoLoad, 93
- AutoRun, 95
- Backup / Restore, 90
- Backup OCS data, 90
- Battery, 100
 - Backup, 100
 - Replacement, 101
 - Warnings, 101
 - When to Replace, 100
- Battery-backed RAM, 61, 96, 98
- Beeper Acknowledgement, 68
- CAN1, 26, 27, 54
- CAN2, 26, 27
- CAN Communications, 26
 - Cscape Programming, 27
 - I/O Expansion (Network I/O), 27
 - Ladder-Controlled, 27
 - Overview, 26
 - Ports, 26
 - Wiring, 26
- CE, 12
- Clone Unit, 96
 - Clone, 96
 - Load Clone, 98
- CLONE.DAT, 63, 97
- COM port(s), 24, 80, 102
- MJ1 Serial Port, 24-27, 33, 57, 58, 80, 83, 103
- Communication Options, 28, 33
 - Modem COM Module (XMC), 33
 - Overview, 33
- Communications Port, 80, 103
- Compliance, 12
- Count, 46, 47
- Cscape Programming
 - Via Serial Port, 25
 - Via CAN Port, 27
- Cscape, 14, 15, 24-28, 33, 35, 36, 38, 41-44, 51, 54, 56, 57, 65, 68, 76, 79, 80-84, 89, 102-104
 - Analog Input Configuration, 87
 - Analog Output Configuration, 88
 - Configuration Procedures, 85
 - Digital Input / HSC Configuration, 85
 - Digital Output / PWM Configuration, 86
 - Establishing Communications, 80
 - Overview, 79
 - Status Bar, 79
- Cscape Configuration, 79
- Datasheet, 9, 13
- Default Gateway, 30
- Device Manager, 103
- Devices to Connect to EXL10, 14
- Digital Inputs, 42
- Dimensions, 18
- Duty Cycle, 49, 51
- Duty Cycle Examples, 51
- Electrical Installation, 22
- Ethernet, 28, 54, 80, 84, 103
- Ethernet Communication, 28
- Ethernet Module
 - Default Gateway, 30
 - Get Settings From, 30
 - IP Address, 30
 - Net Mask, 30
 - Status Register, 30
 - Version Register, 30
- Ethernet Communication, 28
 - Module Configuration, 28
 - Module Protocols and Features, 28
 - Module Specifications, 28
 - Protocol Configuration, 31
 - System Requirements, 28
- Fail Safe, 61, 89
 - AutoLoad, 93
 - AutoRun, 95
 - Backup/Restore Data, 90
 - Overview, 89
 - System Settings, 89
- Features, 14
- Firmware Updates, 100
- Frequency, 44, 45, 49-51
- Fusing, 41
- General I/O, 38
 - Analog Inputs, 42
 - Analog Outputs, 43
 - Digital Inputs, 42
 - Model / I/O Overview, 40
 - Overview, 38

- Relay Outputs, 40
- Removing the I/O Cover, 38
- Solid-State Digital Outputs, 40
- Universal Analog Inputs, 43
- Glossary, High Speed I/O, 44
- Grounding, 12, 19
 - Definition, 22
 - Specification, 22
 - Testing for Good Ground, 22
- High Speed / PWM, 44
- High Speed Counting, 45
- High Speed I/O, 44
- HSC, 44, 45, 47, 85
- I/O Cover Removal, 38
- IP Address, 30
- Jumpers, 38, 42, 43
- Limited Warranty, 3
- Load Clone, 63, 98
- Maintenance, 100
- Make Clone, 63, 97
- Mechanical Installation, 16
- Micro SD Cards, 34
- Minimum Clearance Requirements, 19
- Model / I/O Overview, 40
- Modem COM Module Option, 33
- Mounting Orientation, 17
- Mounting Requirements, 16
 - Panel Door, 16
- Net Mask, 30
- OCS Reference Document Numbers, 15
- Orientation of EXL10 OCS, 17
- Panel Box, 19, 20
- Panel Box Shock and Vibration, 20
- Panel Cut-out, 18
- Panel Cutout Tolerances, 18
- Panel Design Checklist, 20
- Panel Layout / Clearances, 19
- Panel Mounting of an EXL10 Series OCS, 16
- Period Measurement, 46
- Power Connector, 23
- Primary Power Port, 23
- Primary Power Port Pins, 23
- Programming Examples, 3
- Pulse Mode, 45
- Pulse Stream, 45, 46
- Pulse Width Measurement, 45, 86
- Pulse Width Modulation, 44
- PWM, 44, 49, 51, 86
 - Examples, 51
 - Frequency Formula, 51
- Registers, 51
- Quadrature, 44, 45, 47, 86
- References / Useful Documents, 15
- Register Map, 47, 51, 77
- Register Mapping, 38, 40
- Registers, 37, 47, 70, 74
 - %S / %SR, 74
 - Definitions, 74
 - I/O, 77
 - Register Map, 47, 51, 77
 - Resource Limits, 77
- Relay Outputs, 41
- Removable Media, 14, 15, 34, 60, 70, 105
 - Filenames, 37
 - File System, 34
 - Function Blocks in Cscape, 36
 - Load / Save Applications, 35
 - Log Data, 35
 - Manager, 35
 - Manager Submenu, 35
 - Micro SD Cards, 34
 - Overview, 34
 - Save Applications EXL10, 36
 - System Registers, 37
 - Troubleshooting, 105
 - View / Capture, 36
- RS485 Biasing, 25
- RS485 Termination, 25
- Safety / Compliance, 11
- Safety Warnings, Guidelines, 11
- Screen Brightness, 72
- Screen Saver, 71
- Screen Navigation, 67
- Serial Communications, 24
 - Cscape Programming, 25
 - DIP Switches, 24
 - Downloadable Protocols, 25
 - Ladder-Controlled, 25
 - Overview, 24
 - Ports, 24
 - Wiring, 24
- Set Network ID, 84
- Slip, 65
- Solid-State Digital Outputs, 40
- Sourcing, 40, 42
- Status Bar - Cscape, 79
- Stepper, 44, 48, 50
- Stop state, 41-43
- Sub-Menus, 54
- System Menu, 53

- Clone Unit, 62
- Fail-Safe System, 61
- Load Clone, 63
- Removeable Media, 60
- Set Beeper, 59
- Set Date/Time, 58
- Set Fkeys Mode, 57
- Set Networks, 54
- Set Screen, 59
- Set Serial Ports, 58
- View Diags, 55
- View I/O Slots, 56
- View Protocols, 57
- View Status, 54
- System Settings and Adjustments, 53
 - Overview, 53
 - Details, 54
 - Navigate / Edit, 53
- Table of Contents, 5
- Target ID, 83
- Target Indicator, 83
- Technical Support, 2, 15, 42, 101, 102, 105
 - Contacts, 2, 107
- Testing for Good Ground, 22
- Totalize, 45
- Touch screen calibration, 63
- Touch (slip) sensitivity, 65
- Troubleshooting, 102
 - Common problems, 102
 - Connecting Checklist, 103
- CsCAN Checklist, 104
- CsCAN Network, 104
- Ethernet port programming, 103
- Local Controller / I/O, 103
- Local I/O Checklist, 104
- Removable Media, 105
- Serial Port - MJ1, 103
- USB Port - Mini B, 103
- Two-Point Ground Connection Test, 22
- Types of Devices that can be connected to EXL10, 14
- Universal Analog Inputs, 43
- USB, 14, 15, 25, 27, 36, 80-82, 100, 103
- User Interface, 65
 - Alarms, 69
 - Alpha-numeric keypad, 66
 - Beeper Acknowledgement, 68
 - Displaying and entering data, 65
 - Ladder Based Navigation, 68
 - Screen Navigation, 67
 - Touch (slip) sensitivity, 68
- Visual Overview of EXL10 and Topics, 13
- Where to Find Information, 13
- Wiring & Dip Switches, 24
- EXL10 Dimensions, 18
- EXL10 OCS Accessories, 15
- EXL10 OCS Dimensions, 18
- EXL10 OCS Mounting Clip, 17
- EXL10 OCS Mounting Orientation, 17
- XMC, 33

Index of Figures & Tables

Figure 2.1 – Visual Overview of the EXL10 OCS	15
Figure 2.2 – Visual Overview of Types of Devices that can be connected to EXL10 OCS.....	15
Figure 3.1 – Panel Mounting of an EXL10 Series OCS	17
Figure 3.2 – EXL10 OCS with Mounting Clips	18
Figure 3.3 – Orientation of EXL10 OCS	18
Figure 3.4 – Panel Cutout Tolerances	19
Figure 3.5 – EXL10 OCS Dimensions	19
Figure 4.1 – Two-Point Ground Connection Test.....	23
Figure 4.2 – Power Connector (Primary Power Port)	24
Figure 4.3 – Primary Power Port as Viewed Looking at the EXL10 OCS.....	24
Figure 5.1 – Wiring & Dip Switches.....	24
Figure 6.1 – CAN Connectors.....	27
Figure 6.2 – CAN Port Connector.....	28
Figure 7.1 – I/O Configuration Dialog	29
Figure 7.2 – Ethernet Module Configuration.....	29
Figure 9.1 – Removable MicroSD Memory Card Slot.....	36
Figure 9.2 – Removable Media Submenu	35
Figure 10.1 – Removing the I/O Cover.....	38
Figure 10.2 – EXL10 I/O Cover Removed	39
Figure 10.3 – Example Jumper Diagram	39
Figure 10.4 – Typical Output Wiring	42
Figure 10.5 – Relay Fusing	41
Figure 10.6 – Positive & Negative Inputs.....	42
Figure 10.7 – Analog Input Tranzorb Troubleshooting	42
Figure 11.1 – Pulse Width Measurement - High.....	44
Figure 11.2 – Pulse Width Measurement - Low.....	42
Figure 11.3 – Period Measurement - Rising Edges	42
Figure 11.4 – Period Measurement - Falling Edges	42
Figure 11.5 – Quadrature	47
Figure 11.6 – PWM Parameter (Duty Cycle)	49
Figure 11.7 – PWM Parameter (Frequency)	49
Figure 12.1 – System Menu Screenshot	53
Figure 13.1 – Example Screen.....	65
Figure 13.2 – Alpha-numeric Keypad and ASCII Keypad.....	66
Figure 13.3 – Typical Screen Jump Object	67
Figure 13.4 – Force and Switch Coils in Ladder Programming.....	68
Figure 13.5 – Alarm Object	69
Figure 13.6 – Alarm Viewer	69
Figure 13.7 – Removable Media Object.....	70
Figure 13.8 – Removable Media Viewer.....	73
Figure 13.9 – Example application segment for safe removal of removable media	71
Figure 15.1 – Cscape Status Bar.....	79
Figure 15.2 – USB Programming Connector	82
Figure 15.3 – Digital Input / HSC Configuration Dialog.....	85
Figure 15.4 – Digital Output / PWM Configuration Dialog	86
Figure 15.5 – Analog Input Configuration Dialog.....	87
Figure 15.6 – Analog Output Configuration Dialog.....	88
Figure 16.1 – Fail – Safe System Menu	89
Figure 16.2 – Backup / Restore Data	93
Figure 16.3 – Backup Registers.....	93
Figure 16.4 – Restore OCS Data.....	91
Figure 16.5 – Clear Backup Data	91
Figure 16.6 – Flow Chart for Automatic Restore	92
Figure 16.7 – AutoLoad Menu	93
Figure 16.8 – Flow Chart for AutoLoad.....	94
Figure 16.9 – AutoRun Menu.....	95

Figure 17.1 – System Menu 96

Figure 17.2 – Clone Unit Menu Before Cloning 96

Figure 17.3 – Clone Unit Confirm Screen 97

Figure 17.4 – Cloning Status 98

Figure 17.5 – System Menu 98

Figure 17.6 – Clone Unit Menu After Cloning 99

Figure 17.7 – Load Clone Confirm Screen 99

Table 2.1 – EXL10 OCS Accessories 15

Table 2.2 – OCS Reference Document Numbers 15

Table 3.1 – Minimum Clearance Requirements for Panel & Door 19

Table 4.1 – Primary Power Port PINs 23

Table 7.1 – Ethernet Module Protocols & Features 28

Table 7.2 – Ethernet Module Specifications 28

Table 7.3 – Ethernet Status Word Register Format 31

Table 8.1 – XL Series COM Options 33

Table 9.1 – Filename Special Values 31

Table 9.2 – RM Status Values 37

Table 10.1 – I/O & Model Overview 40

Table 11.1 – Glossary of High Speed I/O Terms 44

Table 11.2 – HSC Functions Register Map 48

Table 11.3 – PWM Functions Register Map 51

Table 14.1 – Type of Registers found in the EXL10 OCS 74

Table 14.2 – Common %S Register Definitions 74

Table 14.3 – %SR Registers 74

Table 14.4 – Register Map for EXL10 I/O 77

Table 14.5 – Resource Limits 77

Table 19.1 – Cscape Target & Local Numbers 102

Table 19.2 – Removable Media Troubleshooting 105