

VACON 100
AC DRIVES

**I/O OPTION BOARDS TYPE 'B' AND 'F'
USER MANUAL**

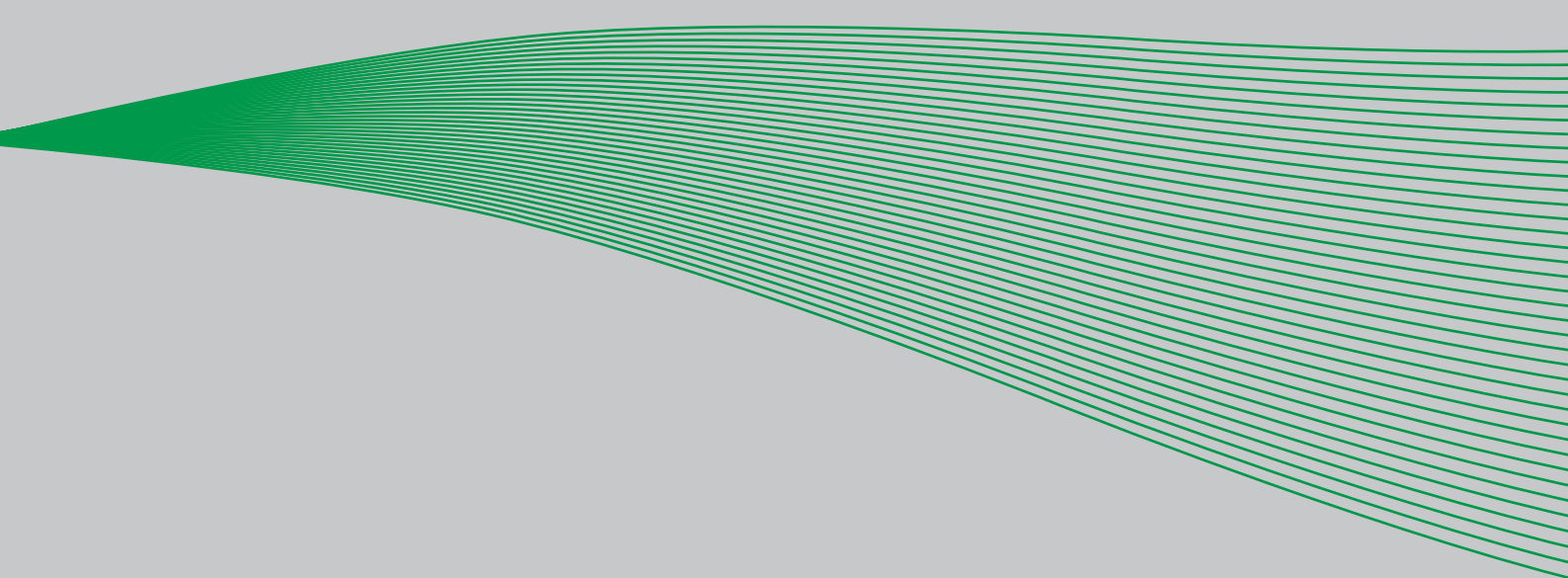

INDEX

Document: DPD00211B
 Order code: DOC-INS06690+DLUK
 Version release date: 18.5.2012

1. General information	3
1.1 Board slots on Vacon 100.....	3
1.2 Option board type B.....	4
1.2.1 Board type B technical data.....	4
1.2.2 Isolation.....	4
1.2.3 Analogue inputs	5
1.2.4 Analogue outputs	5
1.2.5 Control voltage (+24V/ext +24V).....	5
1.2.6 Digital input signal conversions	5
1.3 Hardware protections	8
1.3.1 Terminal block coding	8
1.4 Type identification number	8
1.5 Defining functions to inputs and outputs - programming.....	8
1.5.1 Example programming	8
2. Installation of option boards	11
2.1 Vacon 100 and Vacon 100 HVAC.....	11
2.2 Prepare for use	13
2.3 Control cables	15
2.4 Board information sticker.....	15
3. Description of type 'B' and 'F' boards	17
3.1 Board OPTB1	18
3.1.1 I/O terminals on OPTB1	18
3.1.2 Jumper selections	19
3.2 Board OPTB2.....	20
3.2.1 I/O terminals on OPTB2	20
3.3 Board OPTB4.....	21
3.3.1 I/O terminals on OPTB4	21
3.4 Board OPTB5.....	22
3.4.1 I/O terminals on OPTB5	22
3.5 Board OPTB9.....	23
3.5.1 I/O terminals on OPTB9	23
3.6 Board OPTBF.....	24
3.6.1 I/O terminals on OPTBF	24
3.6.2 Jumper selections	25
3.7 Board OPTBH	26
3.7.1 I/O Terminals on OPTBH.....	26
3.7.2 OPTBH option board wiring scheme:	27
3.7.3 OPTBH board parameters	27
3.8 Boards OPTF3 and OPTF4.....	28
3.8.1 I/O terminals on OPTF3 and OPTF4 boards.....	29

1. GENERAL INFORMATION

Vacon 100 product range embodies a wide selection of expander boards with which the available I/O of Vacon 100 frequency converter can be increased and its versatility improved.

The input and output configuration (I/O) of Vacon 100 is designed with modularity in mind. The total I/O is comprised of basic and option boards, each having its own input and output configuration. The boards contain analogue and digital inputs and outputs and additional application-specific hardware.

The option boards are placed in the board slots on the frequency converter. The I/O boards are usually interchangeable between different Vacon converter types, i.e. Vacon 100 and Vacon NX series. However, the control boards of these types differ from each other to some extent which means that the use of some I/O boards in different Vacon frequency converter types may be restricted.

1.1 BOARD SLOTS ON VACON 100

The control board is situated inside the control unit of the Vacon 100 drive. There are two board slots (labelled D and E) on the Vacon 100 HVAC control board and three board slots (labelled C, D and E) on the Vacon 100 control board. To locate the slots, see page 12. See also the descriptions of the option boards in Chapter 3.

Usually, when the AC drive is delivered from the factory, the control unit includes at least the standard board, which is installed in the standard board slot. The I/O boards mounted at the factory are indicated in the type code of the frequency converter. The expander slots D, E (Vacon100 HVAC) and C, D, E (Vacon 100) are available for different option boards.

1.2 OPTION BOARD TYPE B

Type B option boards are used for I/O expansion. They are interchangeable with the boards of the same type used in Vacon NX series.

1.2.1 BOARD TYPE B TECHNICAL DATA

Safety (all boards)	Comply with EN50178, C-UL and EN60204-1 Inputs/outputs galvanically isolated; Isolation voltage rate 500V
Analogue inputs (AI), voltage	0...±10V, $R_i = 200 \Omega$, single-ended; Resolution 10 bits/0.1%, accuracy ±1% of the full display
Analogue inputs (AI), current	0(4)...20mA, $R_i = 250 \Omega$, differential Resolution 10 bits/0.1%, accuracy ±1% of the full display
Digital inputs (DI), DC-controlled	24V: "0" 10V, "1" 18V, $R_i > 5k\Omega$
Digital inputs (DI), AC-controlled	Control voltage 42...240 VAC "0" <33V, "1" >35V
Auxiliary voltage (output) (+24V)	24V (±15%), max 250mA (total summarized load from ext. +24V outputs, max. 150 mA from one board.
Auxiliary voltage (input) (ext. +24V)	24VDC (±10%, max. ripple voltage 100mV RMS), max. 1A. In special applications where PLC type functions are included in the control unit the input can be used as external auxiliary power supply for control boards as well as I/O boards.
Reference voltage (output) (+10Vref)	10V - 0%...+2%, max. 10mA
Analogue output (AO), current (mA)	0(4)...20mA, $R_L < 500\Omega$, resolution 10 bits/0.1%, accuracy ±2%
Analogue output (AO), voltage (V)	0(2)...10V, $R_L \geq 1k\Omega$, resolution 10 bits, accuracy ±2%
Relay outputs (RO)	Switching capacity 24VDC/8A 250VAC/8A 125VDC/0.4A Max. continuous load 2A rms Min. switching load: 5V/10mA
Thermistor input (TI)	$R_{trip} = 4.7k\Omega$ (PTC type)

Table 1. Type B option boards, technical data

1.2.2 ISOLATION

The control connections are isolated from the mains potential and the I/O ground is connected directly to the frame of the frequency converter. Digital inputs and relay outputs are isolated from the I/O ground. For digital input arrangements, see Chapter Digital input signal conversions on page 5.

1.2.3 ANALOGUE INPUTS

The analogue inputs of the type B boards can be used as either current inputs or voltage (mA/V) inputs (see detailed description of each board). The signal type is selected with a jumper block (B-type boards), or a dip switch (F-type boards) on the board. In case the voltage type input is used you still have to define the voltage range with another jumper block/dip switch. The factory default value for the analogue signal type is given in the description of the board. For detailed information, see the description of the board in question.

1.2.4 ANALOGUE OUTPUTS

The analogue outputs of option boards of type B are used with current (mA) signal only. However, on some certain option boards the signal type (mA/V) can be selected with a jumper/dip switch. See more detailed information on individual boards in chapter 3.

1.2.5 CONTROL VOLTAGE (+24V/EXT +24V)

The control voltage output +24V/EXT+24V can be used in two ways. Typically, the +24V control voltage is wired to digital inputs through an external switch. The control voltage can also be used to power-up external equipment, such as encoders and auxiliary relays.

Observe that the specified total load on all available +24V/EXT+24V output terminals must not exceed 250mA.

The +24V/EXT+24V outputs can further be used to externally power up the control board as well as option boards. If an external power supply is connected to EXT+24V output, the control board and option boards remain live even if mains should be lost on the frequency converter. This ensures sufficient functioning of the control logic (not the motor control, however) and some alarms in exceptional power-loss situations. Furthermore, fieldbus links remain powered which enables e.g. the Fieldbus Master to read valuable data on the frequency converter. **NOTE:** The power unit is not powered through the EXT+24V and therefore the motor control does not work if the mains is lost.

Requirements for an external power back-up:

- output voltage +24DC±10%, max. ripple voltage 100mV RMS
- max. current 1A
- 1A external fuse (no internal short-circuit protection on the control board)

NOTE: Analogue outputs and inputs do not work with only +24V supplied to the control unit.

If there is a +24V/EXT+24V output on the board it is short-circuit protected locally. Should one of the +24V/EXT+24V outputs shortcircuit, the others would remain powered because of the local protection.

1.2.6 DIGITAL INPUT SIGNAL CONVERSIONS

The active signal level depends on which potential the common input CMA is connected to. The alternatives are +24V or Ground (0V). See 1, 2 and 3.

The 24-volt control voltage and the ground for the digital inputs and the common input (CMA) can be either internal or external.

Some typical input signal conversion examples are shown below. If you use the internal +24V from the frequency converter, the following arrangements are possible:

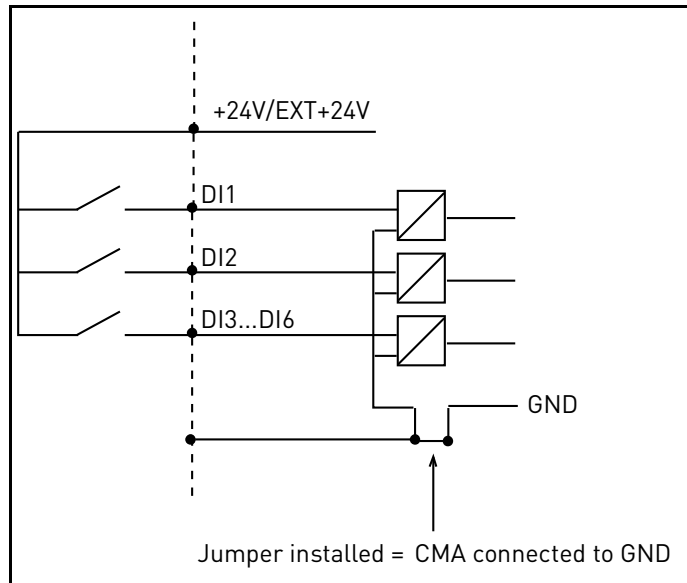

Figure 1. If CMA is connected to GND with inboard jumper the internal +24V is used and the CMA terminal need not be wired

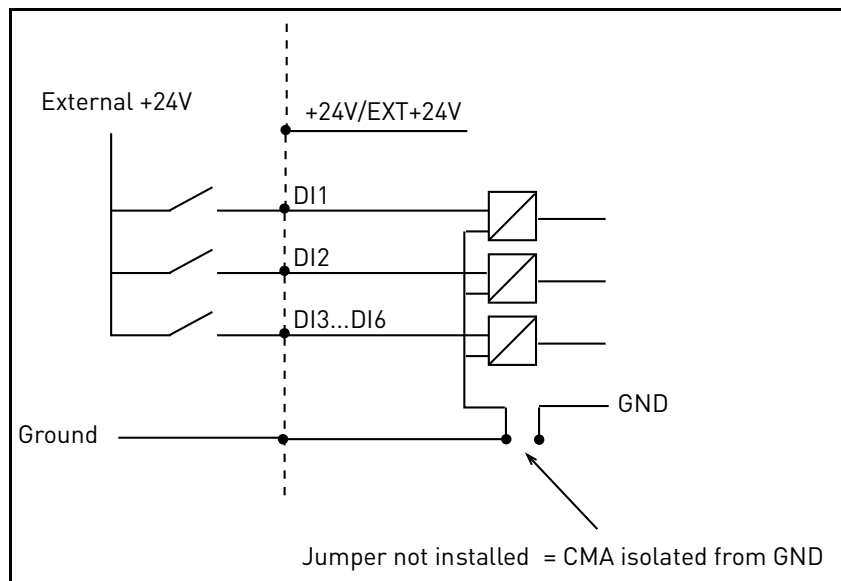

Figure 2. Positive logic with external +24V when CMA is isolated from GND using onboard jumper. The input is active when the switch is closed.

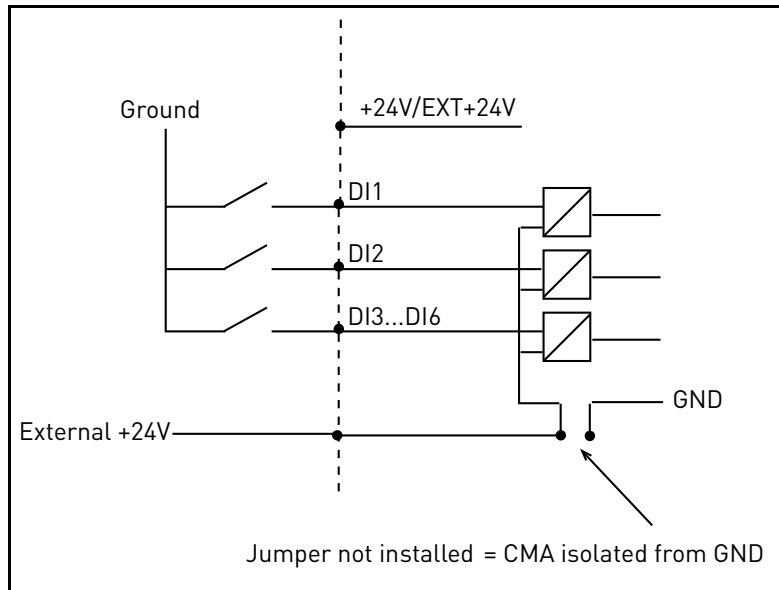

Figure 3. Negative logic with external +24V when CMA is isolated with onboard jumper. The input is active when the switch is closed (0V is the active signal).

You can make the positive and negative logic arrangements also with the internal +24V. Place the jumper block in the 'CMA isolated from GND' position (as above) and wire the CMA terminal to the GND terminal of the frequency converter.

1.3 HARDWARE PROTECTIONS

1.3.1 TERMINAL BLOCK CODING

In order to avoid incorrect connections of terminal blocks to boards, some terminal blocks as well as related terminal connectors on the board are uniquely coded. For more information, see the description of the individual board.

1.4 TYPE IDENTIFICATION NUMBER

NOTE: This information is relevant only for special applications designers using the Vacon Live engineering tool.

Each Vacon OPTxx board has a unique type designation code. Besides the type designation code, each board has a unique Type identification number which is used by the system program to identify which board is plugged into the board slot. The system program and the application use the Type ID also to establish the needed connections in order to achieve the desired functionality of the available I/O boards in the control unit. The ID code is loaded in the memory of the board.

1.5 DEFINING FUNCTIONS TO INPUTS AND OUTPUTS - PROGRAMMING

The programming of digital inputs and outputs is very flexible. There are no digital terminals assigned only for certain function. You can choose the terminal of your choice for the certain function, in other words, functions appear as parameters which the operator defines a certain input for.

1.5.1 EXAMPLE PROGRAMMING

The selectable values of the parameters programmed are of type

DigIN SlotA.1

in which

'DigIN' stands for digital input.

'Slot_' refers to the board; either Vacon AC drive basic boards, or **D** and **E** which are option boards (see 4). The parameter (signal) is not connected to any terminal, i.e. it is not used, if, instead of a letter, the word Slot is followed by a '0' (for example **DigIN Slot0.1**).

The number after the board letter refers to the respective terminal on the selected board. Hence, **SlotX.1** means terminal DI1 on the basic board in board slot A.

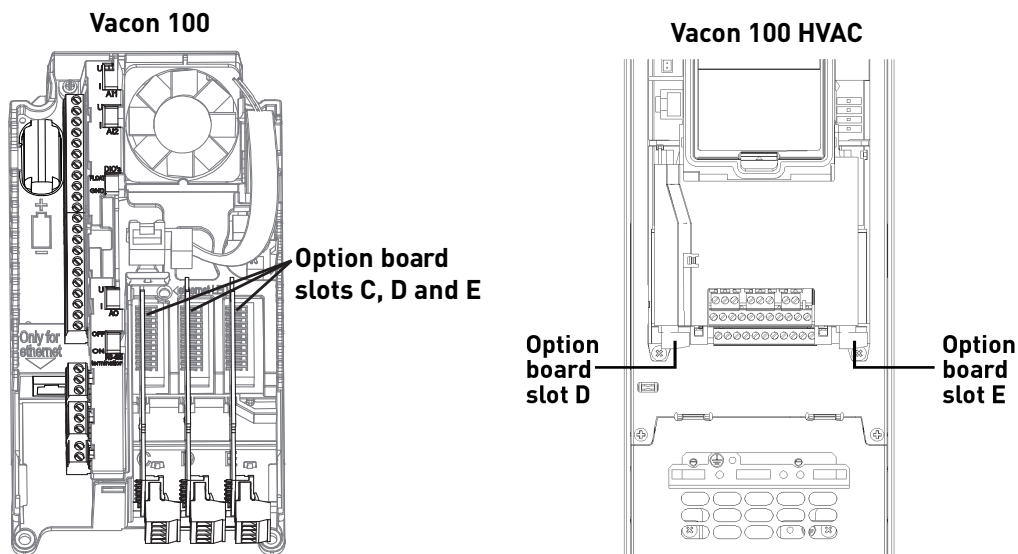

3050.emf

Figure 4. Option board slots

EXAMPLE:

You want to connect the *Control signal 2 A* (parameter M3.5.1.2) to digital input DI2.

1 Locate the parameter *Control signal 2 A* (M3.5.1.2) on the keypad.

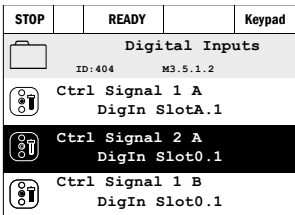
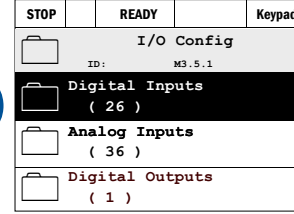
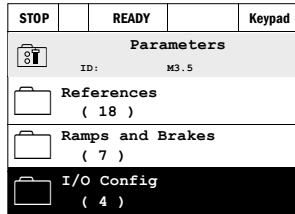
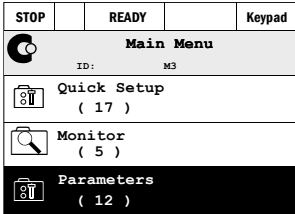

2 Enter the *Edit* mode.

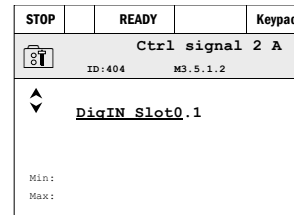
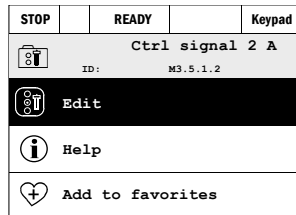
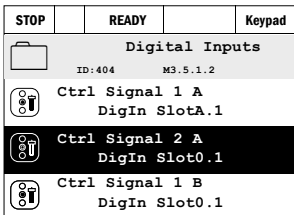

3 **Change the value:** The editable part of the value (DigIN Slot0.1) is underlined and blinking. Change the slot or assign to Time Channel with the arrow keys up and down. Make the terminal value (.1) editable by pressing the right key once and change the value with arrow keys up and down. Accept the change with OK button or return to previous menu level with BACK/RESET button.

 Be ABSOLUTELY sure not to connect two functions to one and same output in order to avoid function overruns and to ensure flawless operation.

NOTE! The assignment of the inputs, unlike of the outputs, cannot be changed in RUN state.

2. INSTALLATION OF OPTION BOARDS

With B-type boards, make sure that the sticker on the connector of the board says “dv” (dual voltage). This indicates that the board is compatible with Vacon drives mentioned in this manual. See below:

NOTE: Incompatible boards cannot be installed on Vacon drives. Compatible boards have a slot coding that enable the placing of the board (see below).

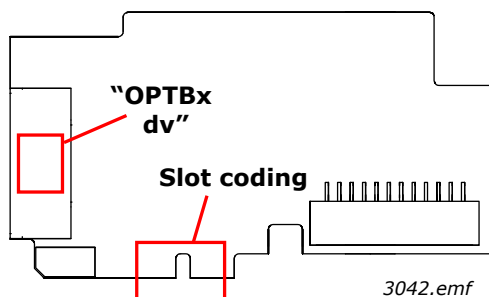

2.1 VACON 100 AND VACON 100 HVAC



NOTE: It is not allowed to add or replace option boards or fieldbus boards on a frequency converter with the power switched on. This may damage the boards.

1

Open the cover of the AC drive.

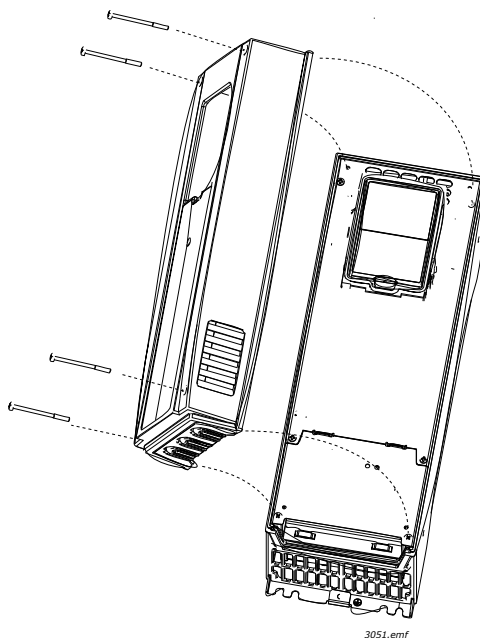

The relay outputs and other I/O-terminals may have a dangerous control voltage present even when Vacon 100 is disconnected from mains.

2

Vacon 100 (left): Open the inner cover (1) to reveal the option board slots (C,D,E) and install the option board (2) into slot C, D or E. Close the inner cover.

Vacon 100 HVAC (right): Open the inner cover (1) to reveal the option board slots (D,E) and install the option board (2) into slot D or E. Close the inner cover.

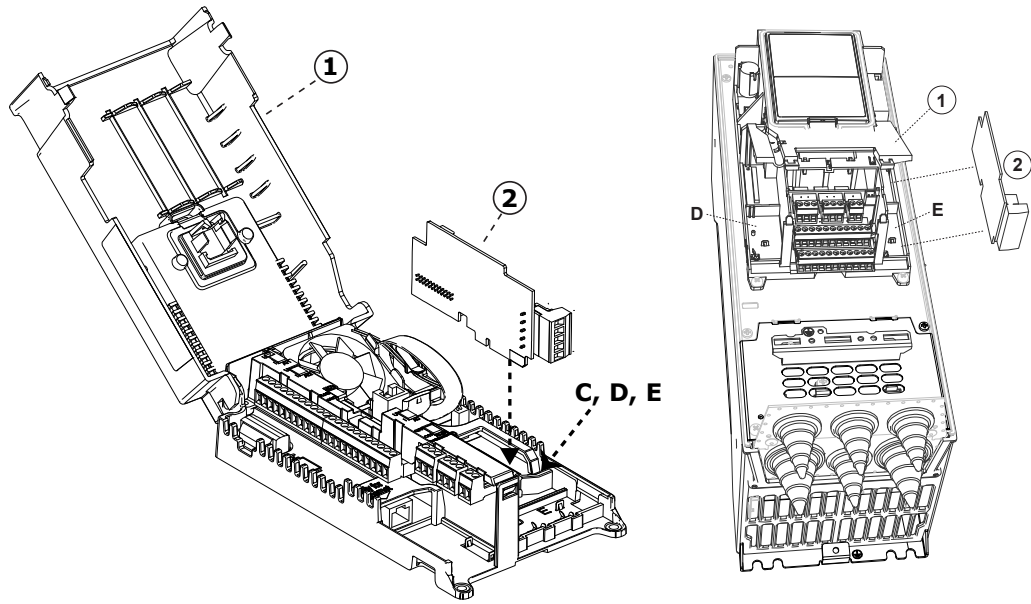

3043.emf

2.2 PREPARE FOR USE

We recommend to ground the control cables in the manner presented below. Note that the images are suggestive, because the cables can vary.

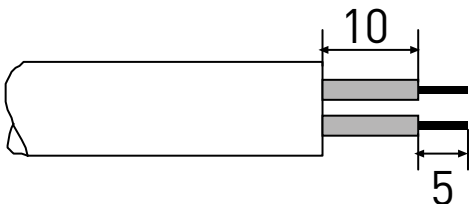
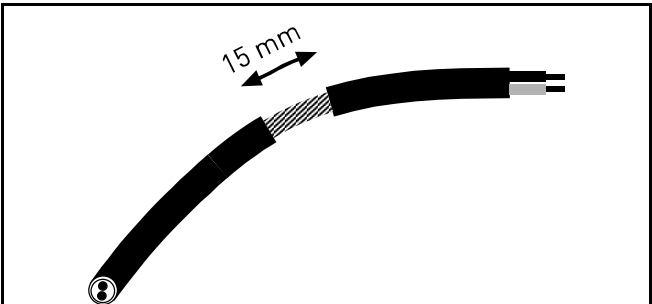
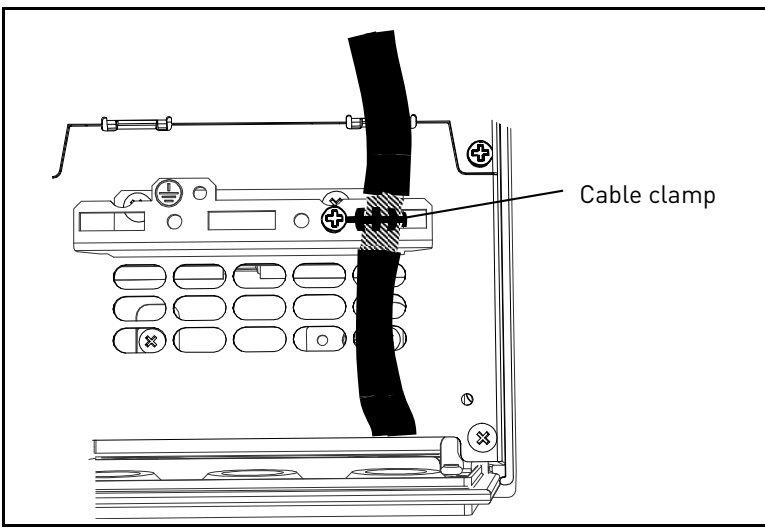
<p>3</p>	<p>Strip about 15 mm of the cable and cut off the grey cable shield. Remember to do this for both cables. Leave no more than 10 mm of the cable outside the terminal block and strip the cables at about 5 mm to fit in the terminals. See picture below.</p>  <p>Also strip the cable now at such a distance from the terminal that you can fix it to the frame with the grounding clamp. Strip the cable at a maximum length of 15 mm. Do not strip the aluminum cable shield!</p> 
<p>4</p>	<p>Then connect the cable to its appropriate terminals on the option board terminal block.</p>
<p>5</p>	<p>Using the cable clamp included in the delivery of the drive, ground the shield of the option board cable to the frame of the AC drive.</p> 

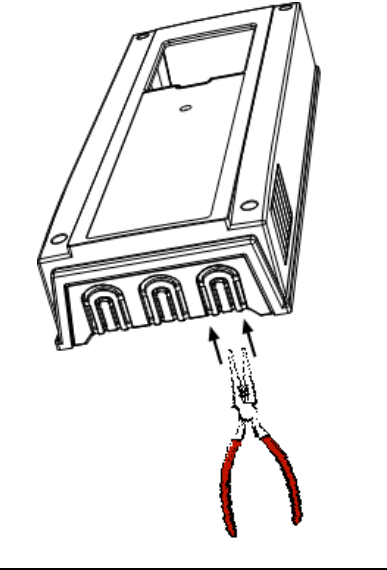
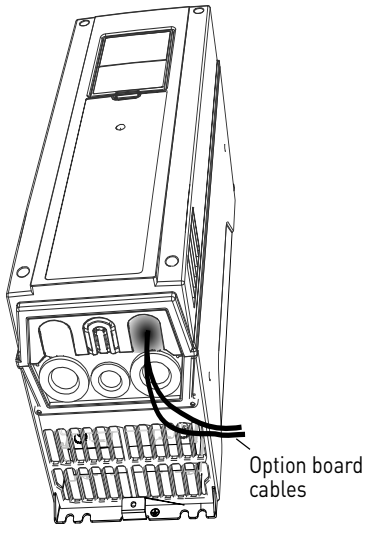
<p>6</p>	<p>Unless already done for the other control cables, cut free the opening on the AC drive cover for the option board cable (protection class IP21). NOTE: Cut the opening on the same side you have installed the board in!</p>	
<p>7</p>	<p>Remount the AC drive cover and run the cable as shown in picture. NOTE: When planning the cable runs, remember to keep the distance between the option board cable and the motor cable at a minimum of 30 cm. It is recommended to route the option board cables away from the power cables as shown in the picture.</p>	

2.3 CONTROL CABLES

The control cables used shall be at least 0.5 mm² screened multicore cables. The maximum terminal wire size is 2.5 mm² for the relay terminals and other terminals.

Find the tightening torques of the control and relay board terminals in Table 2 below.

Terminal screw	Tightening torque	
	Nm	lb-in.
All I/O and relay terminals (screw M3)	0.45	4.00

Table 2. Control cable tightening torques

Cable type	1 st environment	2nd environment	
	EMC levels According to EN61800-3 (2004)		
	Category C2	Category C3	Level T
Control cable	4	4	4

Table 3. Cable types required to meet standards

4 = Screened cable equipped with compact low-impedance shield (JAMAK, SAB/ÖZCuY-0 or similar).

2.4 BOARD INFORMATION STICKER

Each I/O option board package delivered by the factory includes a sticker (shown below) where possible modifications made in the frequency converter are noted. Write the board type, the slot in which it was mounted and the date on the sticker. Finally, attach the sticker on your drive.

Product modified

..... **Date:**

..... **Date:**

..... **Date:**

9004.emf

3. DESCRIPTION OF TYPE 'B' AND 'F' BOARDS

The number of control inputs and outputs on your Vacon AC drive can be increased with the I/O option boards. This kind of boards can usually be placed in all option board slots inside the AC drive.

The boards you wish to have installed in your frequency converter have to be defined in the type designation code of the AC drive when ordering it from the factory.

I/O board	DI	AI	TI	AO	DO	RO	Other
Board OPTB1	(6)				(6)		Programmable
Board OPTB2			1			2	
Board OPTB4		1 (isolated); mA		2 (isolated); mA			+24V/ EXT +24V
Board OPTB5						3	
Board OPTB9	5					1	5 (42-240 VAC)
Board OPTBF				1	1	1	
Board OPTBH							PT100, PT1000, NI1000 KTY84-130 KTY84-150 KTY84-131
Board OPTF3	(6)	2		1		3	
Board OPTF4	(6)	2	1	1		2	

Table 4. Vacon option boards and their equipment

I/O board	Vacon 100	Vacon 100 HVAC
Board OPTB1	C,D,E	D,E
Board OPTB2	C,D,E	D,E
Board OPTB4	C,D,E	D,E
Board OPTB5	C,D,E	D,E
Board OPTB9	C,D,E	D,E
Board OPTBF	C,D,E	D,E
Board OPTBH	C,D,E	D,E
Board OPTF3	A +B	-
Board OPTF4	A +B	-

Table 5. Allowed slots on Vacon drives

DI = Digital input

AI = Analogue input

TI = Thermistor input

AO = Analogue output

RO = Relay output

DO = Digital output

3.1 BOARD OPTB1

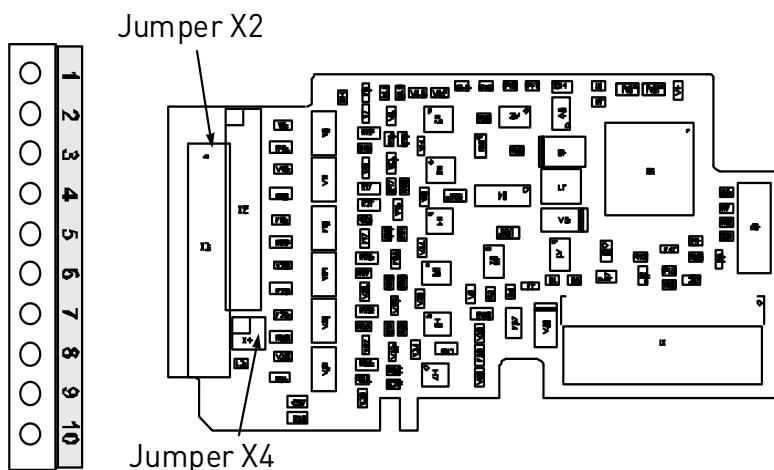

- Description:** Option board with six bidirectional terminals.
- Type ID:** 16945
- Terminals:** One terminal block; Screw terminals (M2.6); No coding
- Jumpers:** 2; X2 and X4

3.1.1 I/O TERMINALS ON OPTB1

OPTB1			
Terminal	Signal	Parameter reference	Technical information
1	Digital input DI01 Digital output DIO1	DigIN SlotX.1 DigOUT SlotX.1	Digital input: 24V; $R_i > 5k\Omega$ Digital output: Open collector, 50mA/48V
2	Digital input DI02 Digital output DIO2	DigIN SlotX.2 DigOUT SlotX.2	See above.
3	Digital input DI03 Digital output DIO3	DigIN SlotX.3 DigOUT SlotX.3	See above.
4	CMA		Common for DI01...DI03. NOTE: CMA is internally connected to GND with jumper by default.
5	Digital input DI04 Digital output DIO4	DigIN SlotX.4 DigOUT SlotX.4	Digital input: 24V; $R_i > 5k\Omega$ Digital output: Open collector, 50mA/48V
6	Digital input DI05 Digital output DIO5	DigIN SlotX.5 DigOUT SlotX.5	See above.
7	Digital input DI06 Digital output DIO6	DigIN SlotX.6 DigOUT SlotX.6	See above.
8	CMB		Common for DI04...DI06
9	GND		I/O ground; Ground for reference and controls.
10	+24V		Control voltage output; Voltage for switches etc.; max. current 150mA; Short-circuit protected.

Table 6. OPTB1 I/O terminals

NOTE: The 'X' given in the Parameter reference shall be replaced by the slot letter. The letter depends on the drive type used, see the Table 5 on page 17.

3.1.2 JUMPER SELECTIONS

On the OPTB1 board, there are two jumper blocks. The jumper block X2 is used to define the bidirectional terminal as either input or output. The other jumper block, X4, is used to connect the common terminals to GND. The factory default and other available jumper selections are presented below.

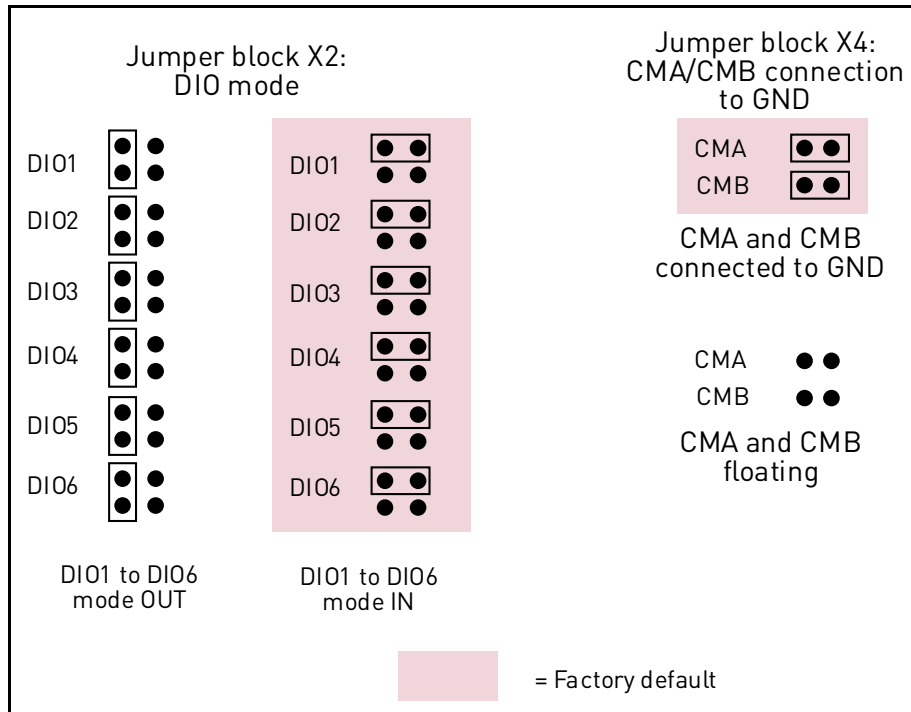

Figure 5. Jumper positions for OPTB1

3.2 BOARD OPTB2



Description: I/O expander board with a thermistor input and two relay outputs.
Type ID: 16946
Terminals: Three terminal blocks; Screw terminals (M3); No coding
Jumpers: None

3.2.1 I/O TERMINALS ON OPTB2

OPTB2			
Terminal	Signal	Parameter reference	Technical information
21 22 23	R01/normal closed R01/common R01/normal open	DigOUT SlotX.1	Switching capacity: 24VDC/8A 250VAC/8A 125VDC/0.4A Min. switching load: 5V/10mA
25 26	R02/common R02/normal open	DigOUT SlotX.2	Switching capacity: 24VDC/8A 250VAC/8A 125VDC/0.4A Min. switching load: 5V/10mA
28 29	T11+ T11-	DigIN SlotX.1	Thermistor input (galvanically isolated) R _{trip} = 4.7kΩ

Table 7. OPTB2 I/O terminals

NOTE: The 'X' given in the Parameter reference shall be replaced by the slot letter. The letter depends on the drive type used, see the Table 5 on page 17.

3.3 BOARD OPTB4

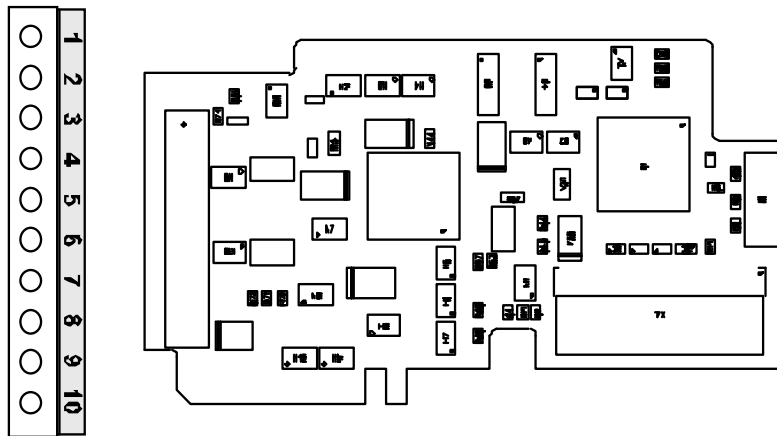

- Description:** I/O expander board with one galvanically isolated analogue input and two galvanically isolated analogue outputs (standard signals 0(4)...20mA).
- Type ID:** 16948
- Terminals:** One terminal block; Screw terminals (M2.6); No coding
- Jumpers:** None

3.3.1 I/O TERMINALS ON OPTB4

OPTB4			
Terminal	Signal	Parameter reference	Technical information
1	AI1+	AnIN SlotX.1	0(4)...20mA; $R_i=250\Omega$; galvanically isolated Resolution 10 bits/0.1%; Accuracy $\pm 1\%$ of the full display
2	AI1-		
3	AO1+	AnOUT SlotX.1	0(4)...20mA; $R_L < 500\Omega$; Resolution 10 bits/0.1%; Accuracy $\leq \pm 2\%$ (galvanically isolated)
4	AO1-		
5	AO2+	AnOUT SlotX.2	0(4)...20mA; $R_L < 500\Omega$; Resolution 10 bits/0.1%; Accuracy $\leq \pm 2\%$ (galvanically isolated)
6	AO2-		
7	GND		24V ($\pm 15\%$); Max. load 250mA (total load from EXT+24V out-puts), max. 150mA from one board. See Figure 1 on page 5. 24V ($\pm 15\%$), in special applications where PLC type functions are included in the control module, this input can be used as external auxiliary power supply for control boards as well as for I/O boards.
8	GND		
9	GND		
10	+24V		

Table 8. OPTB4 I/O terminals

NOTE: The 'X' given in the Parameter reference shall be replaced by the slot letter. The letter depends on the drive type used, see the Table 5 on page 17.

3.4 BOARD OPTB5

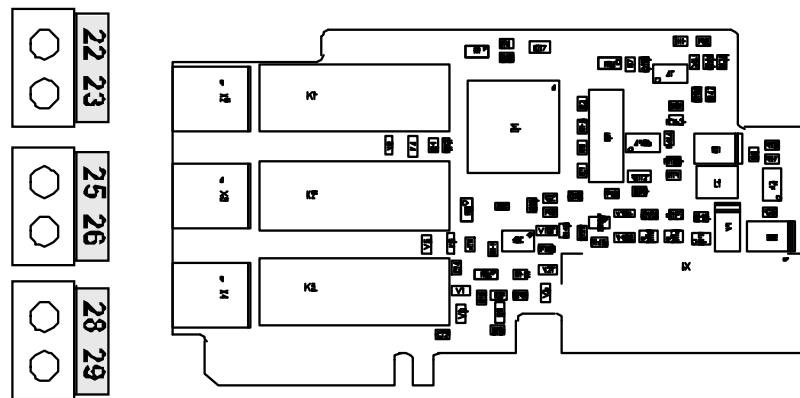

Description: I/O expander board with three relay outputs
Type ID: 16949
Terminals: Three terminal blocks; Screw terminals (M3); No coding
Jumpers: None

3.4.1 I/O TERMINALS ON OPTB5

OPTB5			
Terminal	Signal	Parameter reference	Technical information
22 23	R01/common R01/normal open	DigOUT SlotX.1	Switching capacity: 24VDC/8A 250VAC/8A 125VDC/0.4A Min. switching load: 5V/10mA
25 26	R02/common R02/normal open	DigOUT SlotX.2	Switching capacity: 24VDC/8A 250VAC/8A 125VDC/0.4A Min. switching load: 5V/10mA
28 29	R02/common R02/normal open	DigOUT SlotX.3	Switching capacity: 24VDC/8A 250VAC/8A 125VDC/0.4A Min. switching load: 5V/10mA

Table 9. OPTB5 I/O terminals

NOTE: The 'X' given in the Parameter reference shall be replaced by the slot letter. The letter depends on the drive type used, see the Table 5 on page 17.

3.5 BOARD OPTB9

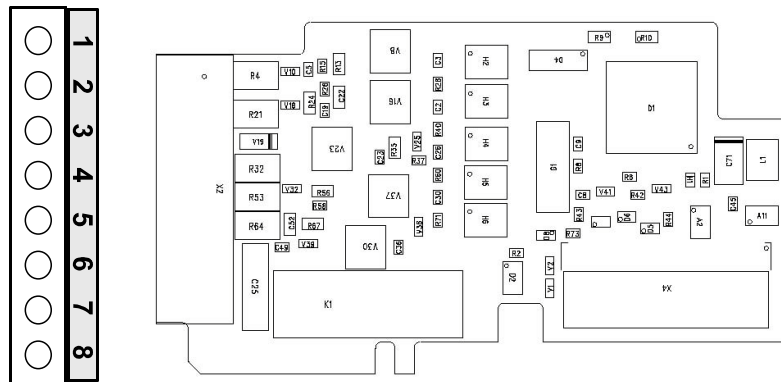

Description: I/O expander board with five 42...240 VAC digital inputs and one relay output.

Type ID: 16953

Terminals: One terminal block; Screw terminals (M2.6); No coding

Jumpers: None

3.5.1 I/O TERMINALS ON OPTB9

OPTB9			
Terminal	Signal	Parameter reference	Technical information
1	ACIN1	DigIN SlotX.1	Digital input, 42...240 VAC (threshold 35V) Control voltage: "0" <33V, "1" >35V
2	ACIN2	DigIN SlotX.2	Digital input, 42...240 VAC (threshold 35V) Control voltage: "0" <33V, "1" >35V
3	ACIN3	DigIN SlotX.3	Digital input, 42...240 VAC (threshold 35V) Control voltage: "0" <33V, "1" >35V
4	ACIN4	DigIN SlotX.4	Digital input, 42...240 VAC (threshold 35V) Control voltage: "0" <33V, "1" >35V
5	ACIN5	DigIN SlotX.5	Digital input, 42...240 VAC (threshold 35V) Control voltage: "0" <33V, "1" >35V
6	COMA		Common for inputs
7 8	RO1/common RO1/normal open	DigOUT SlotX.5	Switching capacity 24VDC/8A 250VAC/8A 125VDC/0.4A

Table 10. OPTB9 I/O terminals

NOTE: The 'X' given in the Parameter reference shall be replaced by the slot letter. The letter depends on the drive type used, see the Table 5 on page 17.

3.6 BOARD OPTBF

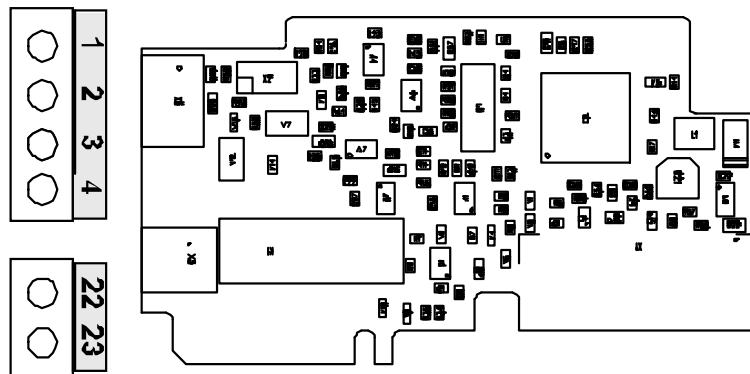

Description: I/O expander board with analogue output, digital output and relay output.
Type ID: 16966
Terminals: Two terminal blocks; Screw terminals (M2.6 and M3); No coding
Jumpers: 1; X2

3.6.1 I/O TERMINALS ON OPTBF

OPTBF			
Terminal	Signal	Parameter reference	Technical information
1	A01+	AnOUT SlotX.1	0(4)...20mA; $R_L < 500\Omega$; Resolution 10 bits/0.1%; Accuracy $\leq \pm 2\%$ (Not isolated)
2	A01-		
3	DO1	DigOUT SlotX.1	0(2)...10V; $R_L < 1k\Omega$; Resolution 10 bits/0.1%; Accuracy $\leq \pm 2\%$ (Non isolated) mA / V -selection with jumper X2
4	GND		Digital output: Open collector, 50mA/48V (Not isolated)
22 23	RO1/Common RO1/normal open	DigOUT SlotX.2	Switching capacity: 24VDC/8A 250VAC/8A 125VDC/0.4A Min. switching load: 5V/10mA

Table 11. OPTBF I/O terminals

NOTE: The 'X' given in the Parameter reference shall be replaced by the slot letter. The letter depends on the drive type used, see the Table 5 on page 17.

3.6.2 JUMPER SELECTIONS

On the OPTBF board, there is one jumper block for selecting the analogue output mode (mA/V). The factory default and other available jumper selections are presented below.

Jumper block X2:
A01 mode

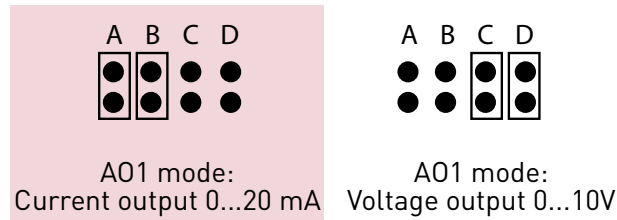

 = Factory default

3067.emf

3.7 BOARD OPTBH

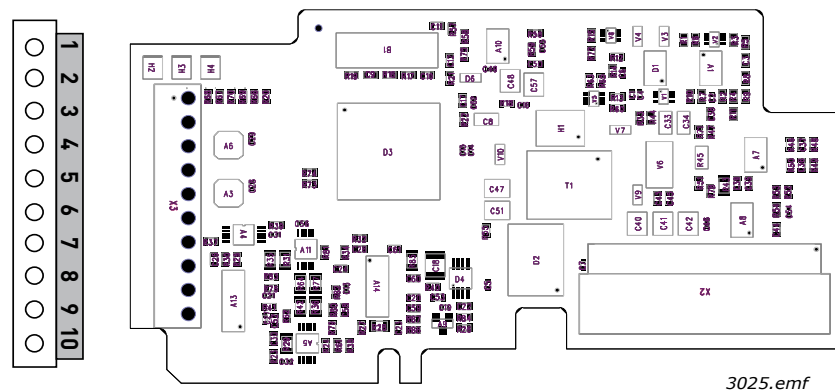

- Description:** Temperature measurement board with three individual channels.
- Supported sensors:** PT100, PT1000, NI1000, KTY84-130, KTY84-150, KTY84-131
- Type ID:** 16968
- Terminals:** One terminal block; Screw terminals (M2.6); No coding
- Jumpers:** None

3.7.1 I/O TERMINALS ON OPTBH

Terminal	Parameter reference Keypad	Technical information
1 2 3	R1.1 R1.2 R1.3 AnIn:X.1	Temperature sensor input 1, -50...200 °C Accuracy ±1°C
4 5 6	R2.1 R2.2 R2.3 AnIn:X.2	Temperature sensor input 2, -50...200 °C Accuracy ±1°C
7 8 9	R3.1 R3.2 R3.3 AnIn:X.3	Temperature sensor input 3, -50...200 °C Accuracy ±1°C
10	NC	

3.7.2 OPTBH OPTION BOARD WIRING SCHEME:

Use shielded cables and connect the cable shield to grounding clamp in the drive.
Allowed sensor configurations are shown in the figures below:

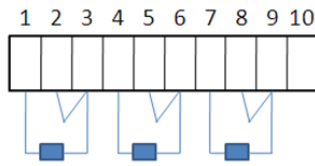

Two-wire configuration

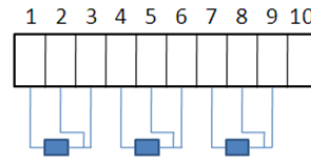

Three-wire configuration

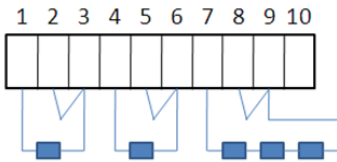

Two-wire configuration

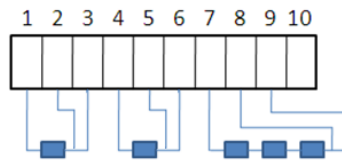

Three-wire configuration

3.7.3 OPTBH BOARD PARAMETERS

NOTE! The correct sensor for the correct channel must be selected. Always configure unused channels to 0 = No sensor

Code	Parameter	Min	Max	Unit	Default	ID	Description
7.x.1.1	Sensor 1 type	0	6		0		0 = No Sensor 1 = PT100 2 = PT1000 3 = Ni1000 4 = KTY84 5 = 2 x PT100 6 = 3 x PT100
7.x.1.2	Sensor 2 type	0	6		0		See above
7.x.1.3	Sensor 3 type	0	6		0		See above

3.8 BOARDS OPTF3 AND OPTF4

OPTF3:

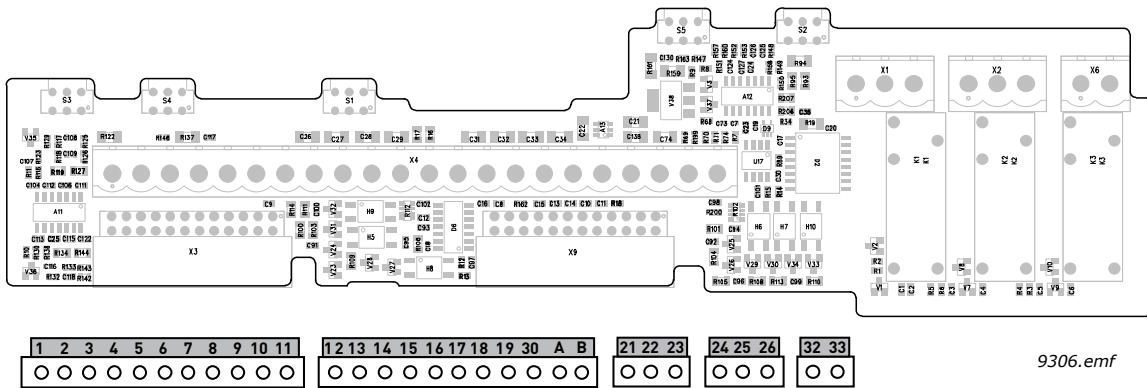

- Description:** Basic I/O and relay board.
- Type ID:** 17971
- Terminals:** Five terminal blocks; Screw terminals (M3); coding
- Dip switches:** 5 (see Vacon 100 Installation manual, ch. 6.1.2 for more information)

OPTF4:

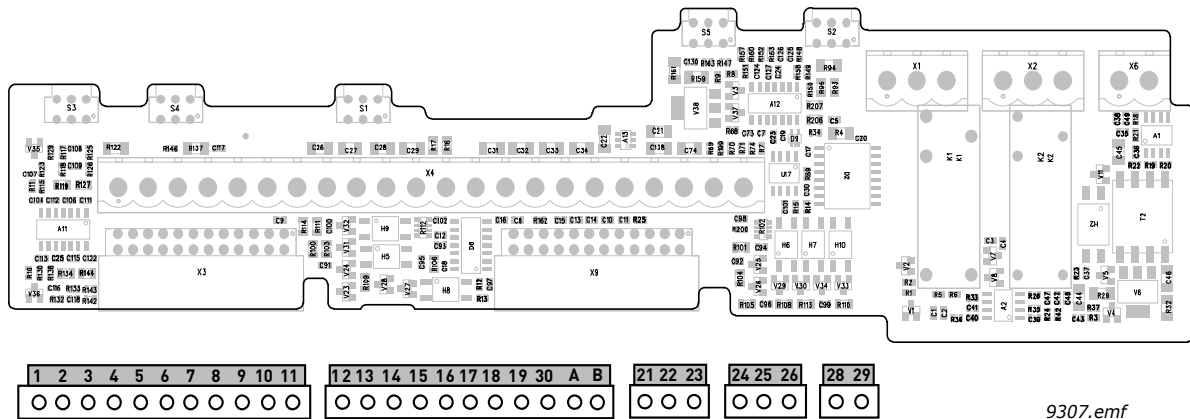

- Description:** Basic I/O, relay and thermistor board.
- Type ID:** 17972
- Terminals:** Five terminal blocks; Screw terminals (M3); coding
- Dip switches:** 5 (see Vacon 100 Installation manual, ch. 6.1.2 for more information)

NOTE: See detailed technical data on boards OPTF3 and OPTF4 in Vacon 100 Installation manual, ch. 8.2.1!

3.8.1 I/O TERMINALS ON OPTF3 AND OPTF4 BOARDS

OPTF3, OPTF4		
Terminal		Signal
1	+10 Vref	Reference output
2	AI1+	Analogue input, voltage or current
3	AI1-	Analogue input, common (current)
4	AI2+	Analogue input, voltage or current
5	AI2-	Analogue input, common (current)
6	24Vout	24V auxiliary voltage
7	GND	I/O ground
8	DI1	Digital input 1
9	DI2	Digital input 2
10	DI3	Digital input 3
11	CM	Common for DI1 - DI6
12	24Vout	24V auxiliary voltage
13	GND	I/O ground
14	DI4	Digital input 4
15	DI5	Digital input 5
16	DI6	Digital input 6
17	CM	Common for DI1 - DI6
18	A01+	Analogue signal (+output)
19	A01-/GND	Analogue output common
30	+24Vin	24V auxiliary input voltage
A	RS485	Serial bus, negative
B	RS485	Serial bus, positive
21	R01/1 NC	Relay output 1
22	R01/2 CM	
23	R01/3 NO	
24	R02/1 NC	Relay output 2
25	R02/2 CM	
26	R02/3 NO	

OPTF3:

32	R03/2 CM	Relay output 3
33	R03/3 NO	

OPTF4:

28	TI1+	Thermistor input
29	TI1-	

VACON

DRIVEN BY DRIVES

Find your nearest Vacon office
on the Internet at:

www.vacon.com



Manual authoring:
documentation@vacon.com

Vacon Plc.
Runsorintie 7
65380 Vaasa
Finland

Subject to change without prior notice
© 2012 Vacon Plc.

Document ID:



Order code:



Rev. B